



CMAA

CONCRETE MASONRY
ASSOCIATION OF AUSTRALIA

PA05

Concrete Flag
Pavements -
Design and
Construction
Guide

While the contents of this publication are believed to be accurate and complete, the information given is intended for general guidance and does not replace the services of professional advisers on specific projects. Concrete Masonry Association of Australia cannot accept any liability whatsoever regarding the contents of this publication.

Copyright © Concrete Masonry Association of Australia 2014.

ABN 33 065 618 804.

This publication, its contents and format are copyright of the Concrete Masonry Association of Australia, and may not be reproduced, copied or stored in any medium without prior, written authorisation from the Institute. Concrete Masonry Association of Australia is wholly sponsored by the Australian concrete brick, block and paver industry. Local or state regulations may require variation from the practices and recommendations contained in this publication.

The Standards referenced in this manual were current at the time of publication.

Cover: Quadro Honed - Rhodes

Manufacture: Adbri Masonry



PO Box 370, Artarmon NSW 1570 Australia
Suite 3.02, Level 3, 44 Hampden Road Artarmon NSW 2064 Australia
Telephone +61 2 8448 5500 Fax +61 2 9411 3801
ABN 30003873309

www.cmaa.com.au

CONCRETE MASONRY ASSOCIATION OF AUSTRALIA

CONCRETE FLAG PAVEMENTS – DESIGN AND CONSTRUCTION GUIDE

Associate Professor Brian Shackel

School of Civil and Environmental Engineering, University of New South Wales.

Alan Pearson

Concrete Masonry Association of Australia

CONTENTS

1	Introduction	2
2	Background and Scope	2
3	Definitions	3
4	Choice of Concrete Flag	4
5	Design of Flag Pavement	5
6	Materials	10
7	Construction and Detailing	11
8	References	14

Disclaimer: The Concrete Masonry Association of Australia Limited is a non-profit organisation sponsored by the concrete masonry industry in Australia to provide information on the many uses of concrete masonry products. Since the information provided is intended for general guidance only and in no way replaces the service of professional consultants on particular projects, no liability can be accepted by the Association for its use.

Industry Support. Most of the manufacturers of quality concrete masonry products in Australia are members of the Concrete Masonry Association of Australia (CMAA). It is recommended that advice be obtained from local CMAA members to adapt or supplement information contained in this Guide.

Remember, when working with cement and concrete/mortar or manufactured or prefabricated concrete products, ALWAYS follow the manufacturer's instructions and seek advice about working safely with the products from the manufacturer, your nearest WorkCover Authority or Worksafe Australia.

1 Introduction

Large format pavers (ie typically 300 mm x 300 mm and greater in plan) or “*flags*” have long been accepted as one of the most attractive and durable methods of pavement surfacing. Recently in Australia, flag pedestrian surfacing has been rediscovered by landscape architects and specifiers.

The diversity of colours and surface textures enables architects, engineers and specifiers to design sympathetic demarcation large-format flag pavements embracing scale and aesthetics, particularly in pedestrian areas.

Flags in many pavement situations need to be able to withstand commercial vehicle axle loads.

Hitherto, in Australia, there has been no industry or national code of practice for the specification, design and detailing of flag pavements. This Guide seeks to fulfill this role.

2 Background and Scope

This design guide is for flexible pavements surfaced with concrete flags which may carry occasional traffic eg pedestrian malls, etc. Concrete flag pavements are not suitable for roads or streets carrying high traffic volumes. Here, conventional segmental concrete pavements are the recommended solution. This guide is restricted to the specific flag sizes, thicknesses, strengths and traffic intensities detailed therein and should not be extrapolated to other conditions. For concrete pavers having a gross plan area of less than 0.08 m², design should be according to the *Design Guide for Residential Accessways and Roads*, PA02 1997¹³

For trafficked pavements the design recommendations set out herein apply only for square concrete flags having the plan dimensions and minimum thicknesses given in **Table 1**. This guide is for concrete flags laid on bedding sand only and does not apply to natural stone, brick or ceramic pavers, tiles or concrete flags which are adhered to rigid substrates. The design curves for vehicle traffic given herein are appropriate for concrete flags laid on bedding sand.

3 Definitions

Flags

Large format concrete pavers with a gross plan area greater than 0.08 m², used in combination with a bedding course to form a surfacing layer.

Pedestrian Pavements

Pavements subject only to foot traffic. These include footpaths not subject to vehicle over-run or parking, pedestrian precincts which are completely closed to vehicle access, residential paths and patios and hard landscaping.

Low Volume Residential paths, paths in public gardens, pavements at schools or campuses, hard landscape areas, common outdoor areas of residential buildings. Suburban shopping area pavements, pedestrian areas around institutional buildings, sporting or recreational areas. Pavements with less than 3000 passes per day.

Medium Volume Pavements with greater than 3000 and less than 30,000 passes per day.

High Volume Pavements with high-volume pedestrian traffic exceeding 30,000 passes per day – typically inner-city and major suburban pedestrian malls and paths.

Pedestrian and Light Vehicle Pavements

Pavements carrying pedestrians and light vehicles (LV) only. This includes residential driveways.

Pedestrian and Commercial Vehicles Pavements

Areas carrying both pedestrian and mixed vehicular traffic. Normally mall traffic will comprise a mix of light vehicles such as delivery vans with a gross weight less than 3 tonnes and commercial vehicles such as trucks, emergency and service vehicles having gross weights of 3 tonnes or more. This category includes commercial vehicle crossovers, driveways carrying occasional truck traffic, footpaths subject to truck overrun or parking, pedestrian malls accepting service vehicles and commercial vehicles, pedestrian crossings and lightly trafficked streets.

Light Vehicles

Light vehicles (LV) are vehicles which when fully-loaded have a gross weight less than 3 tonnes. This category includes cars, utilities, delivery vans and some light 2-axle trucks.

Commercial Vehicles

Commercial vehicles (CV) are vehicles having a gross weight of 3 tonnes or more and which comply with state or commonwealth legislation for the axle loads, tyre pressures and dimensions of normal on-road vehicles. Off-road, industrial, oversize, abnormally loaded or overloaded vehicles are specifically excluded from this guide. This vehicle category principally comprises 2 and 3 axle trucks. Trucks having 5 axles or more should not comprise more than 5% of the commercial vehicles.

If data on the gross weights of the vehicles to be carried on the pavement are not available then all vehicles fitted with dual tyres and all trucks shall be classed as commercial vehicles.

4 Choice of Concrete Flag

To minimise damage to the flags occurring in-service it is important that the correct type of concrete flag be chosen to match the intended traffic application. It is necessary to ensure that the combined effects of the dimensions and strengths of the flags are adequate for the proposed use. The plan dimensions, minimum thicknesses and minimum strengths that are required are given in **Table 1** for the 3 types of application described in **Chapter 3**. above.

Concrete flags shall comply with the minimum strengths set out in **Table 1** for all categories of use. In the case of dimensions, no restriction is placed on the flag dimensions for pavements subject to purely pedestrian traffic, but for pavements carrying light vehicles a minimum thickness of 50 mm is required. For pavements carrying commercial vehicles, restrictions are placed on both the plan dimensions and minimum thicknesses. Deviation from these dimensions is not permitted where commercial vehicles are to be carried.

TABLE 1 Concrete Flag Properties

Pavement application ¹	Vehicle traffic ²	Nominal size mm	Minimum Thickness mm	Characteristic breaking load ^{3,4} kN	Dimensional deviations (work size dimensions) mm				Abrasion resistance (mean) ⁵ for pedestrian volume			Slip resistance classification (Class)
					Plan		Height		Low	Medium	High	
					SD ⁶	Mean	SD ⁶	Mean				
Pedestrian only	Nil	Any	Any	5.0	1	± 1.5	1	± 2	7	5	3.5	W
Pedestrian and light vehicles (LV) only	LV only	Any up to 450 x 450	50	7.0	1	±1.5	1	± 2	7	5	3.5	W
Pedestrian/commercial vehicles (CV) only, streets	<100,000 CV's	300 x 300	60	13.8	1	± 1.5	1	± 2	7	5	3.5	W
		400 x 400	65	15.5	1	± 1.5	1	± 2	7	5	3.5	W
		450 x 450	70	18.8	1	± 1.5	1	± 2	7	5	3.5	W
AS/NZS Standard	Not applicable	Not applicable	AS/NZS 4456.5	AS/NZS 4456.3 Method B	AS/NZS 4456.9			AS/NZS 4586				

NOTES:

- 1 Salt resistance for concrete flags is determined by Test Method – AS/NZS 4456.10
- 2 For CV traffic >100,000 an interlocking concrete segmental pavement should be designed, specified and detailed in accordance with PA01, PA02 and PA03^{12,13,14}
- 3 At 28 days
Characteristic Value – the value that will be exceeded by at least 95% of the units in the lot (see AS/NZS 4455.1.4.5)
Lot – a group of units of a single type with specific characteristics and dimensions presented for sampling at the same time (see AS/NZS 4455.1.4.13)
- 4 It is common to test at an early age and correlate results
- 5 At 90 days
- 6 SD = Standard deviation

5 Design of flag Pavement

5.1 Pedestrian Pavement

Where the pavement is to be completely free of vehicular traffic this guide places no restriction on the type and thickness of basecourse to be used. However, it is strongly recommended that a basecourse of at least 75-mm compacted thickness be used and that the bedding sand meets the requirements of Table 6.

A typical cross-section for pavements carrying only pedestrian traffic is given in Figure 1. This is for guidance only.

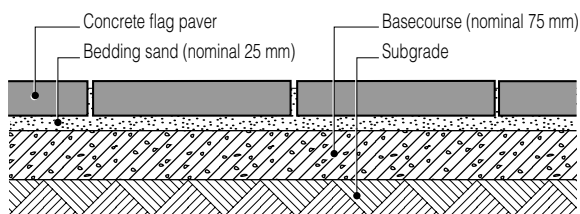

Figure 1 Typical Cross Section – Pedestrian-only Pavement

5.2 Vehicle Pavement

This design methodology applies to concrete flags installed over an engineered base of either unbound crushed rock or cement-stabilised base. These materials shall comply fully with the requirements set out in Chapter 6 of this Guide.

The design of flag pavements should follow the flow chart, Figure 2, with the following steps being implemented.

STEP 1

Determine whether the pavement is to carry any vehicles. If there is no traffic, proceed to STEP 6.

STEP 2

Characterise the Subgrade Strength.

The subgrade strength shall be characterised in terms of a *Design CBR* value. Where the pavement is to carry commercial vehicles this should be a representative soaked CBR value based on laboratory tests. For pedestrian areas and pavements subject only to light traffic the CBR may be estimated from soil classification data or by selecting presumptive values, following Table 2 as a guide.

Where the subgrade CBR is less than 4% the use of a select subgrade material (capping layer) or subgrade stabilisation with lime and/or cement should be considered (see Clause 6.3).

TABLE 2 Presumptive Subgrade Strengths

Soil type	Unified soil classification	Presumptive subgrade CBR (%)
Gravel	GP, GW, GM	20
Sand	SM, SW, SP	10
Silt – well drained	ML	5
Silt – poorly drained	ML	2
Sandy clay – well drained	SC	6
Sandy clay – poorly drained	SC	2
Highly plastic clay – well drained	CH	5
Highly plastic clay – poorly drained	CH	2

Providing for Low-Strength Subgrades

Where the pavement is to carry traffic, low strength subgrades require special attention during design. Moreover, irrespective of design loads, some low-strength subgrade soils may present construction difficulties which can be addressed by aspects of thickness design and materials selection.

For the purposes of this Guide, a *low-strength subgrade* is classified as one having a design CBR of 4% or less. A *very-low-strength subgrade* is classified as one having a design CBR of 2% or less. Such subgrades can present difficulties in achieving a firm and stable platform for basecourse construction in their unmodified form using conventional compaction methods. The following options may be considered, subject to the designer's assessment of individual site conditions.

Stabilisation The subgrade may be suitable for chemical stabilisation by lime, fly ash, ground granulated slag, cement or a combination of these depending on subgrade material type, availability of stabilisation additives and required post-stabilisation properties. For pavements within the scope of this Guide, a minimum compacted depth of stabilisation of 150 mm is recommended.

Very-Low-Strength Subgrades For very-low-strength subgrades, it may become necessary to use techniques that achieve a firm and stable platform for construction without compaction using rollers. Two typical solutions are:

Lean-Mix Concrete. Provision of a layer of lean-mix concrete having a nominal minimum 28-day compressive strength of 5 MPa. The use of lean-mix concrete for stabilisation under the above conditions assumes that a separate basecourse will be required. Typical values which may be used in design are 28-day compressive strengths for lean-mix concrete are in the range 5–15 MPa, with elastic moduli within the range 10 000–15 000 MPa.

Geotextile Fabric. Overlaying the subgrade with a layer of geotextile fabric sometimes with a coarse granular surcharge. The assessment of design subgrade CBR and other design factors after using a geofabric for subgrade stabilisation needs to be discussed with the fabric supplier and is outside the scope of this Guide. However, the use of woven geofabrics is generally to be preferred to other fabrics for this application.

Concrete Flag Pavements
Design and Construction Guide

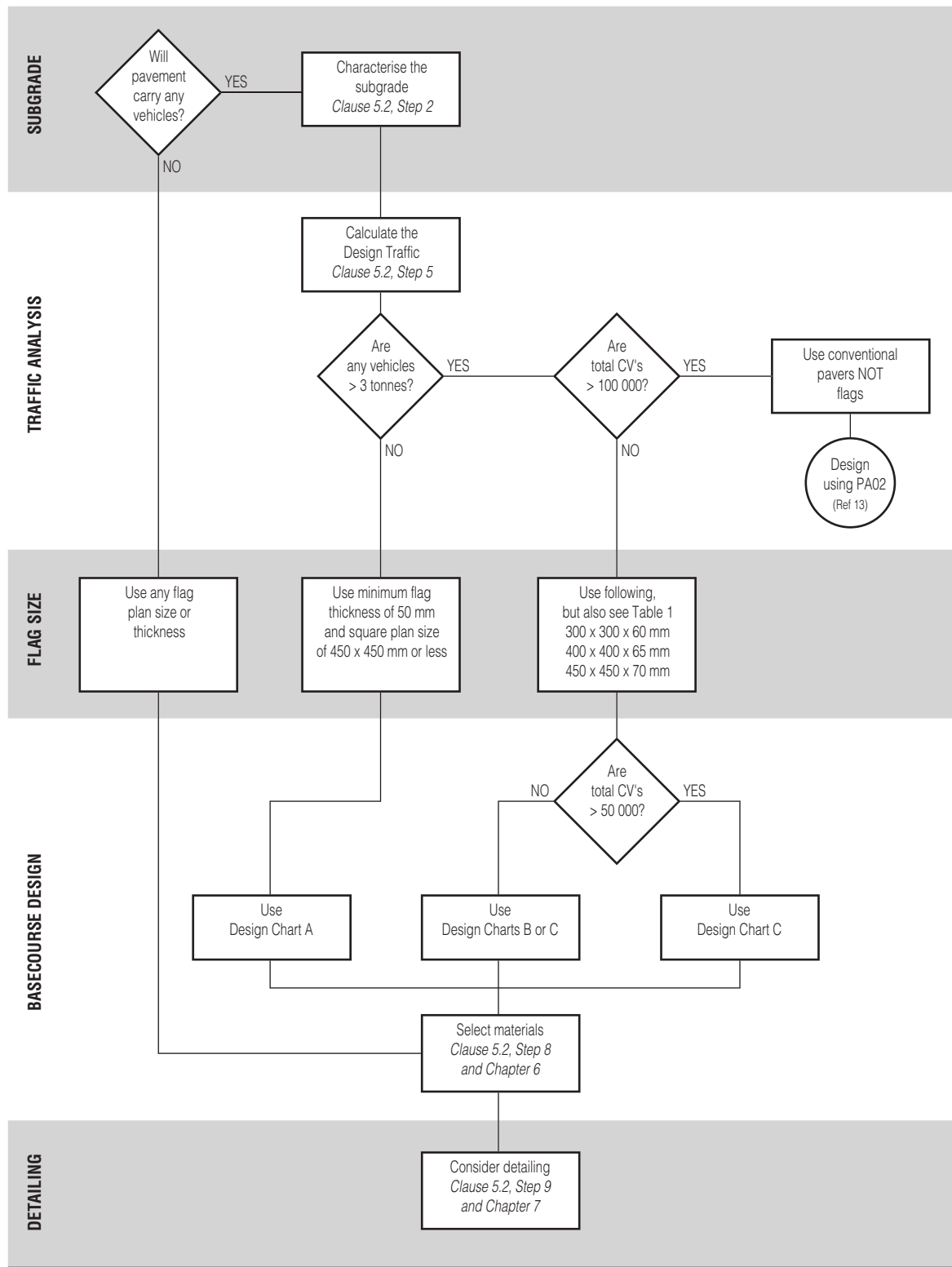

FIGURE 2 Flag Pavement Design Process

STEP 3

Determine the **Traffic Category**.

The following cases are considered:

- **No Vehicular traffic.** Here the pavement will not be subject to any vehicles. Proceed to **STEP 6**.
- **Light vehicles only.** Here the pavement will carry only vehicles having a gross weight < 3 tonnes.
- **Commercial vehicles.** Where the pavement is to carry any vehicles having a gross weight ≥ 3 tonnes.

STEP 4

Determine the **Design Period**.

The design period of the pavement, *P*, is the period in years for which the pavement is planned to serve without renewal or relaying. This will vary according to the application and should be determined by discussion with the client. However, typical design periods are:

- Pedestrian precincts – 10 to 15 years
- Malls – 10 years
- Pedestrian crossings – 10 years
- Minor Streets – 10 to 20 years

STEP 5

Calculate the **Design Traffic**.

For pedestrian precincts and malls the design traffic should be calculated for locations in which the traffic is concentrated, eg entry points from the neighbouring street system.

Light Vehicles (LV)

The number of light vehicles is estimated for the Design Period. This should include all vehicles having a gross weight < 3 tonnes including cars, vans and light trucks. This is then the Design Traffic. Proceed to **STEP 6**.

Commercial Vehicles (CV)

Obtain the Average Annual Daily Traffic (AADT) in one direction and the percentage of commercial vehicles, *C* (%), from traffic surveys. The Design Traffic is then given by:

$$\text{Design Traffic} = \text{AADT} \times L \times 365 \times G \times C / 100$$

Equation 1

Here *G* is a growth factor that reflects the expected annual increase in traffic (if any) and is given by:

$$G = [(1 + i/100)^P - 1] / (i/100)$$

Equation 2

where *i* = annual growth in traffic (%)

P = design period (years)

Where there is no expected traffic growth (*i* = 0) then *G* = *P*

L is a lane or distribution factor reflecting the distribution of traffic across the pavement. For pedestrian precincts and malls assume that *L*=1.0 at entrances and where the traffic is channelised. Elsewhere, values of *L* between 0.65 and 1.0 can be assumed depending on the traffic distribution.

For streets, the lane factor, *L*, may be chosen from **Table 3**.

TABLE 3 Lane Distribution Factors

Number of lanes in each direction	Minimum Lane Factor, <i>L</i>
1	1.00
2	0.85
3 or more	0.65

TABLE 4 Minimum Number of Commercial Vehicles

Application	Number of CVs per day
Residential	1
Shopping areas	10
Malls and Precincts	20

Where the Average Annual Daily Traffic, AADT, is not available then an estimate of the number of commercial vehicles can be based on **Table 4**.

The number of CVs indicated by **Table 4** is the absolute minimum number for which a flag pavement should be designed even if traffic counts predict lower vehicle movements. However, **Table 4** is no substitute for accurate traffic data. The lane distribution factor, *L*, shall not be applied to any traffic estimate based on **Table 4**.

Check that the use of flags is appropriate. If the Design Traffic given by **equation 1** exceeds 100 000 commercial vehicles then the use of concrete flag pavements is not appropriate and conventional concrete segmental pavers should be selected. In such cases, exit this Guide and use PA02¹³ *Concrete Segmental Pavements – Design Guide for Residential Accessways and Roads*.

STEP 6

Choose the **Flag Dimensions**.

Flag dimensions shall comply with those set out in **Table 1** except where the pavement is completely free of vehicular traffic.

- **Pedestrians only** There are no restrictions on plan dimensions or thickness of the flags.
- **Pedestrian and Light Vehicles only** Choose a minimum flag thickness of 50 mm with square plan dimensions of 450 x 450mm or less .
- **Pedestrian and Commercial vehicles** Choose the appropriate flag size from **Table 1**.

STEP 7

Design **Base Thickness** from the Design Charts.

The pavement shall be designed by reference to the appropriate Design Chart selected from **Table 5**.

TABLE 5 Choice of Design Chart

Design Vehicles	Design Chart
Light traffic only	Use Design Chart A
Traffic < 50 000 CVs	Use Design Charts B or C
Traffic ≥ 50 000 CVs	Use Design Chart C only

**Concrete Flag Pavements
Design and Construction Guide**

The Design Charts allow the use of either unbound granular base or cement-treated base selected according to the Design CBR and Design Traffic. Materials and construction standards for these base materials are set out in **Chapter 6**. For pavements carrying only light traffic (vehicles < 3 tonnes) the thickness of base required is independent of the type of base chosen (**Design Chart A**). However, where commercial vehicles are to be carried, the required thicknesses of unbound granular base and cement-treated base are different (**Design Charts B and C** respectively).

For both bound and unbound materials the minimum thickness of base shall not be less than 150 mm where the pavements are to carry commercial vehicles and not less than 100 mm where the pavement is subject only to light vehicles < 3 tonnes gross weight.

It is recommended that, at design feasibility stage at least, a cost comparison is made for a series of basecourse designs. In some cases, the increased cost of a higher quality basecourse may be offset by the reduced costs of shallower excavation and disposal of lesser amounts of excavated material, particularly in urban areas.

In general, a cement-bound basecourse will be less susceptible to the effects of moisture ingress in areas subject to heavy rainfall and will offer better performance.

The final design decision can be made on an informed basis from an assessment of the combination of materials availability, costs and engineering judgement. However, experience shows that better in-service performance can often be achieved where cement-treated base is chosen in preference to unbound granular base especially where drainage is poor.

Irrespective of the type and thickness of base chosen, the Design Charts assume that the flags will be laid on a sand bedding layer having a compacted thickness of 25 mm and meeting the requirements of **Table 6**.

STEP 8

Select bedding, jointing and basecourse materials, see **chapter 6**.

STEP 9

Consider detailing as covered in **Chapter 7**. Additional detailing information is available in **PA01**¹⁴ *Concrete Segmental Pavements – Detailing Guide*.

DESIGN CHART A FOR LIGHT VEHICLES ONLY (LESS THAN 3 TONNE GROSS WEIGHT)

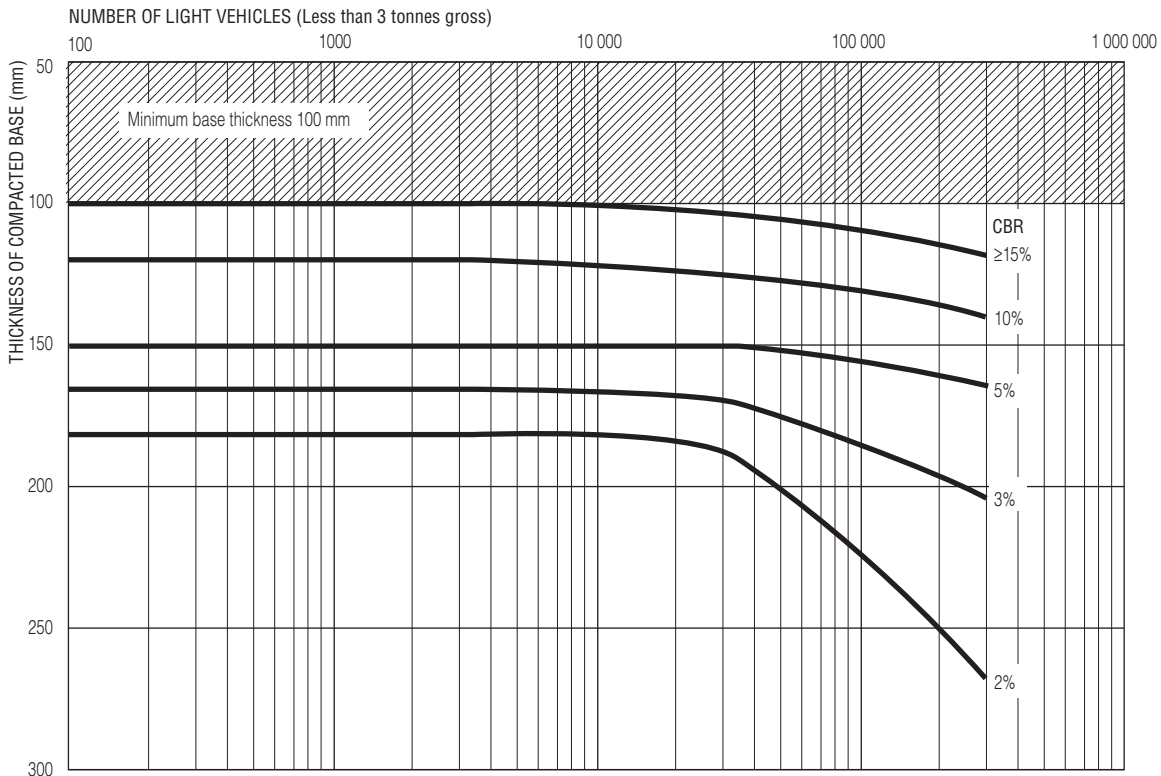

DESIGN CHART B

FOR UP TO 50 000 COMMERCIAL VEHICLES ONLY

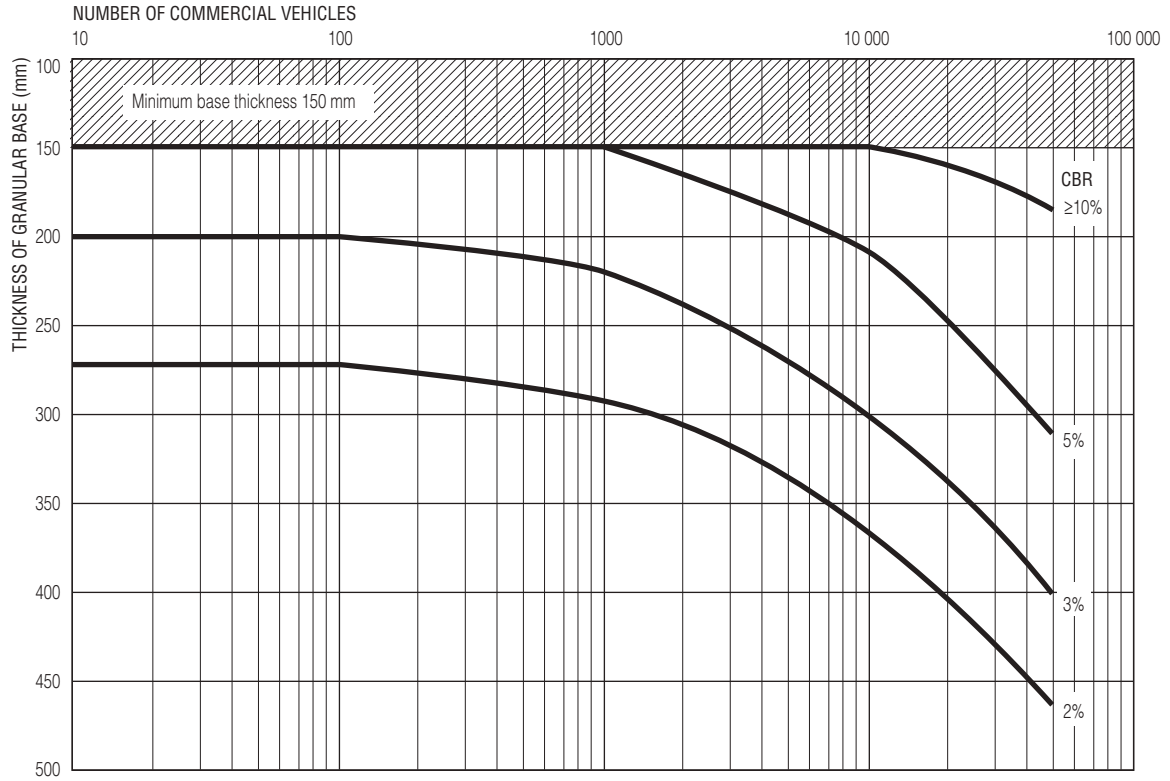

DESIGN CHART C

FOR UP TO 100 000 COMMERCIAL VEHICLES

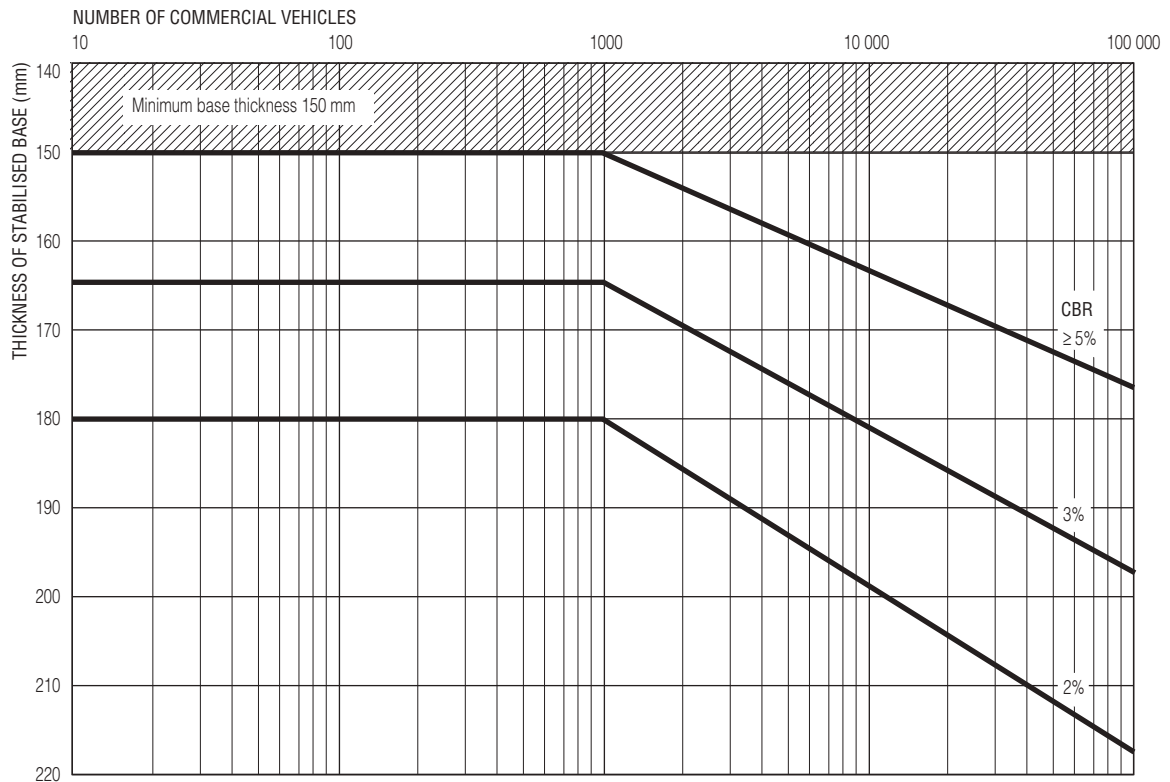

6 Materials

6.1 Bedding Sand

For design and performance reasons concrete flags should be laid on bedding sand nominally 25 mm thick.

Bedding sand shall be within the grading limits given in **Table 6**.

TABLE 6 *Bedding Sand Gradings*

Sieve Size	% Passing
9.52 mm	100
4.75 mm	90 – 100
2.36 mm	80 – 100
1.18 mm	50 – 85
600 microns	25 – 60
300 microns	10 – 30
150 microns	5 – 15
75 microns	0 – 10

Where the pavement is to carry commercial vehicle traffic, the proportion of material smaller than 75 microns shall not exceed 2%. Adequate provisions for draining the bedding sand shall be provided.

Bedding course sand should have a moisture content not exceeding 8% and be kept reasonably constant throughout the laying.

6.2 Jointing Sand

A nominal joint width of 2–5 mm should be maintained with jointing sand being brushed into the joints. The joints shall be completely sand-filled and additional sand shall be added to top up if necessary.

The jointing sand shall be hard, sharp and contain not more than 3% by weight of clay or silt and also be within the grading limits shown in **Table 7**.

TABLE 7 *Jointing Sand Gradings*

Sieve Size	% Passing
2.36 mm	100
1.18 mm	90 – 100
600 microns	60 – 90
300 microns	30 – 60
150 microns	15 – 30
75 microns	5 – 10

Jointing sand must be dry.

6.3 Basecourse Materials

6.3.1 Granular Base

Granular base shall comply fully with the requirements of a Class A material as set out in **Table 8**.

To maximise the use of economically-available materials and as specifications vary among State and Municipal Authorities, the following information should be used as a guide to preferred minimum requirements only. Designers should take into account local specifications, materials availability and experience.

Granular materials should comply with local requirements for basecourse for an asphalt-surfaced pavement. The material may be either a crushed quarry material or a natural gravel.

TABLE 8 *Properties of unbound granular basecourse material*

Property	Maximum nominal aggregate size 20 mm	
	Class A	Class B
% passing sieve size:		
26.5 mm	100	100
19.0 mm	95 – 100	95 – 100
13.2 mm	78 – 92	78 – 92
9.5 mm	68 – 83	68 – 83
4.75 mm	44 – 64	44 – 64
2.36 mm	29 – 47	30 – 48
425 microns	12 – 20	14 – 23
75 microns	2 – 6	6 – 10
Liquid limit (max)	20	20
Plasticity index (max)	6	6
Los Angeles Test % loss (max)	40	40
CBR after soaking at 98% modified maximum dry density	100% (min)	80% (min)

The information in **Table 8** is representative of specifications issued by Australian road authorities.

6.3.2 Cement-Stabilised Materials

These materials are designed to have sufficient strength and therefore elastic modulus for this property to be taken into account in thickness design.

In areas of high rainfall or where the water table is high, these materials offer improved performance compared with unbound materials. They are less susceptible to the effects of moisture ingress.

Cement-treated materials shall meet the grading requirements of **Table 8** for Class A or B materials and, after the addition of cement, shall achieve a 7-day unconfined compression strength of not less than 2.0 MPa and not more than 5.0 MPa.

Cementitious material meeting the requirements of a GP or GB cement in accordance with AS 2972 will usually be suitable as a binder. Where aggressive ground water may be present, the use of a sulphate-resistant binder should be considered.

In the absence of local experience, the required binder content should be determined by laboratory testing. As a guide, a cement content in the range 3–5% by weight of untreated material will often be suitable. The moisture content should not exceed that required for field compaction.

6.3.3 Basecourse Compaction

The base shall be compacted to not less than 98% of modified maximum dry density to AS 1289 for Class A granular base and to not less than 96% of modified maximum dry density for cement-stabilised base.

7 Construction and Detailing

7.1 General

For design and performance reasons, concrete flags should be laid on bedding sand nominally 25 mm thick (see **Clause 6.1**).

A nominal joint width of 2–5 mm should be maintained with jointing sand being brushed into the joints (see **Clause 6.2**).

Where concrete flags are laid abutting kerbs or drainage channels, the surface of the flags shall be at least 5 mm above the kerb or channel.

The difference in level between two adjacent flags shall not exceed 3 mm.

7.2 Cutting and Laying

Concrete flags shall be cut where necessary using a saw or disc cutter.

Where square pavers are to be cut, eg to permit installation in stretcher bond, the cut pavers shall be placed in areas away from traffic. The minimum plan area of the cut pavers shall not be less than 50% of the normal (uncut) plan area.

Where less than 25% of the flag needs to be cut away it may be left as a single flat, as shown in **Figure 3 (a)**.

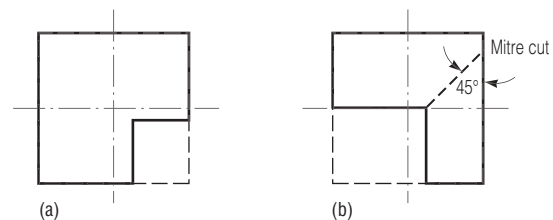

FIGURE 3 Cutting of Flag Pavers

Where more than 25% of the flag must be cut away then the remaining shape must be mitred out from the internal corner of the cut out to the external corner of the flag as shown in **Figure 3(b)**.

7.3 Crossings

A vehicle crossover will be needed where the footpath and driveway are at the same level. The kerbs should be placed into the required position and the adjacent line of flags ramped to the footpath level. The two corner concrete flags should be cut diagonally to form the mitred ramp (see **Figure 4**).

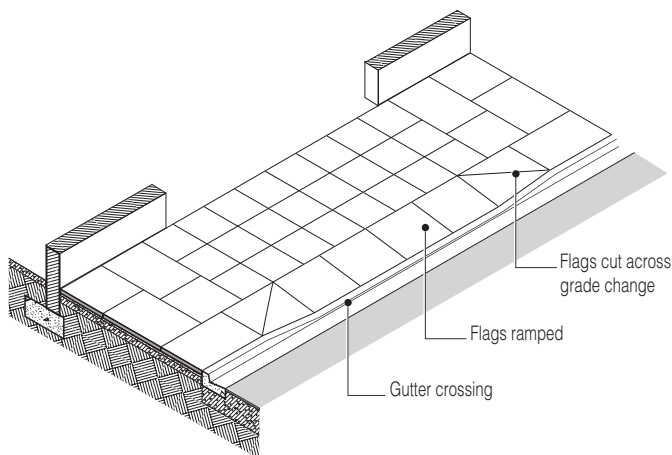

FIGURE 4 Crossings at Footpath Level

Where the footway is higher than the driveway a dropped crossing is necessary. The two lines of flags in line with the dropper kerbs shall be ramped across the width of the footpath to the driveway level as shown in Figure 5. The flags shall be installed in a stretcher rather than a straight line bond as shown in Figure 5.

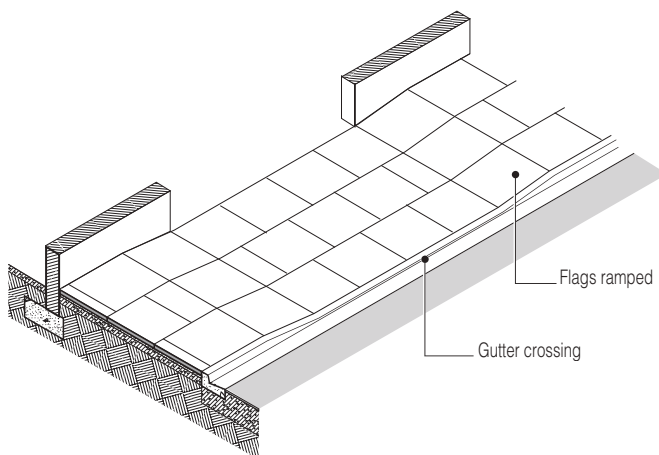

FIGURE 5 Crossings below Footpath Level

7.4 Changes in Grade

To accommodate abrupt changes in grade and ensure that the finished project is aesthetically pleasing, the flag plan dimensions may require altering. This should be achieved by specifying a smaller paver size in the area of gradient change. In areas carrying traffic the reduced plan dimensions should remain essentially square.

7.5 Edge Restraints

Edge restraints shall be provided around the periphery of concrete flag pavements to the full depth of the flag and bedding sand. Edge restraints may comprise adjacent structures, kerbs, channels, etc and shall be capable of preventing the loss of bedding sand and minimising the sideways movement of the flags. The edge restraints must

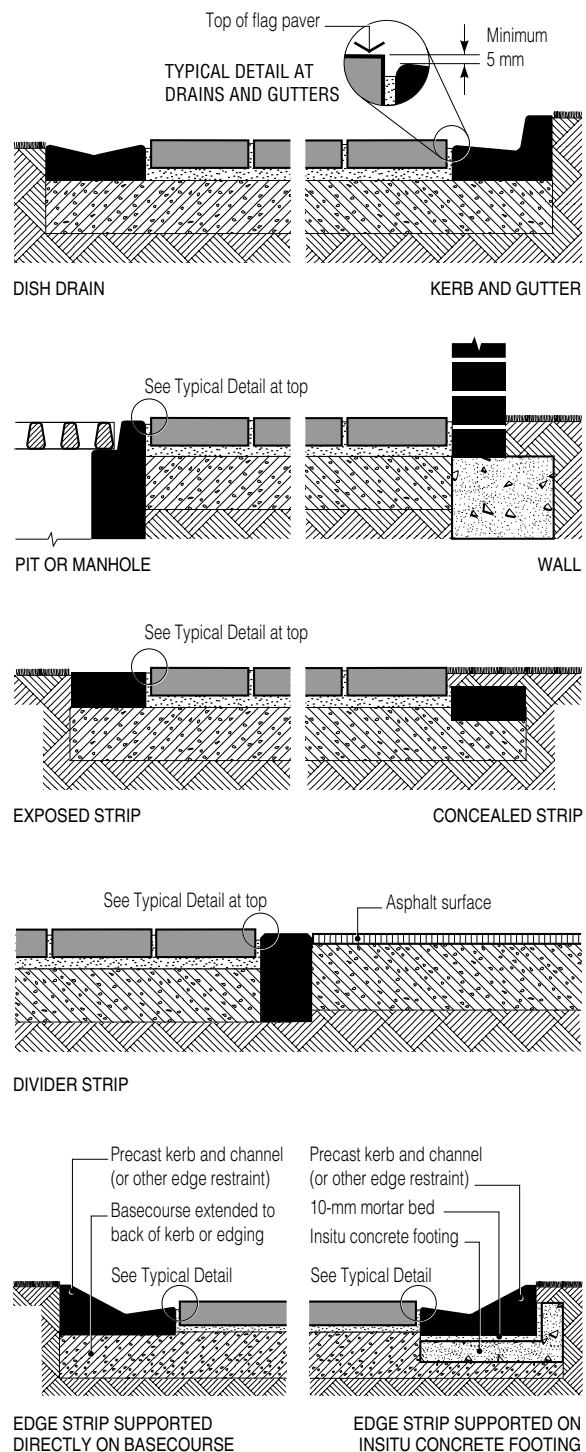

also be capable of accepting traffic loads.

FIGURE 6 Edge Restraint Details

Some of the important detailing requirements for edge restraints are shown in Figure 6. These include:

- The top of flags should be 5 mm above the front edge of the edge restraint to which they are draining so that water will not pond on the pavement.
- The edge restraint should have a vertical or near-vertical side on the face which abuts the flag.

- The basecourse should extend below the edge restraint for its full width (to minimise the likelihood of the edge restraint itself being disturbed) except at situations such as walls or pits.
- Where the edge restraint is in the form of a standard road-authority kerb, gutter/channel or dish drain, the requirement of that authority in relation to concrete quality should be followed. Elsewhere the use of a Grade N32 concrete is recommended.

See also **Figure 9** for surface drainage and **Figure 10** for bedding sand drainage details.

7.6 Bond or Laying Pattern

The two most common flag paving patterns are shown in **Figure 7** and comprise:

- stack bond
- stretcher bond.

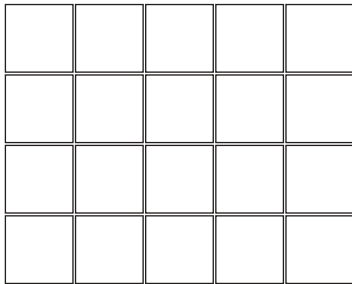

(a) STACK BOND

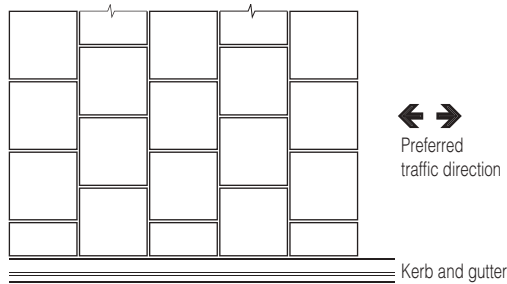

(b) STRETCHER BOND

FIGURE 7 Flag Paver Laying Patterns

7.7 Manhole Surrounds and Intrusions

Flags can be cut to fit around manholes or other intrusions in the pavement. Cut edges of a flag can impair the overall appearance; a good solution is to replace the cut flags with rectangular block paving, as illustrated in **Figure 8**.

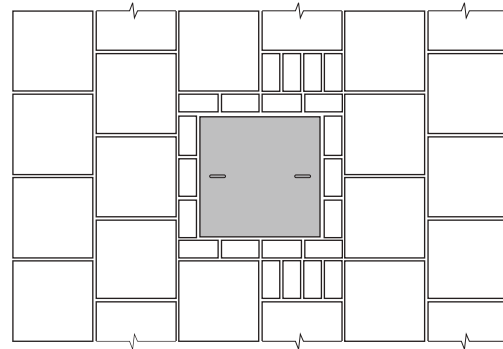

ARRANGEMENT 1

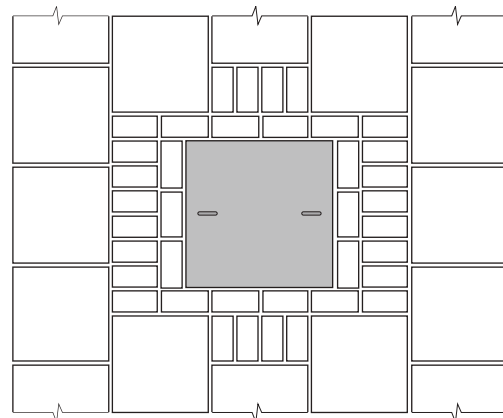

ARRANGEMENT 2

FIGURE 8 Treatment of Manholes in Flag Pavement

7.8 Surface Drainage

Surface drainage channels may be incorporated within flag pavements (**Figure 9**). To allow for future settlement the finished pavement surface level should be 5 mm proud of the edge of the drainage unit after compaction of the flags.

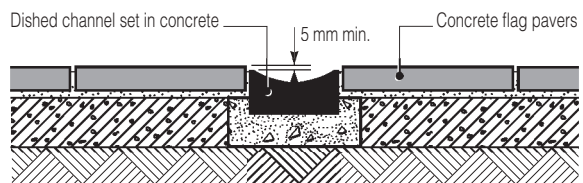

DISHED CONCRETE CHANNEL

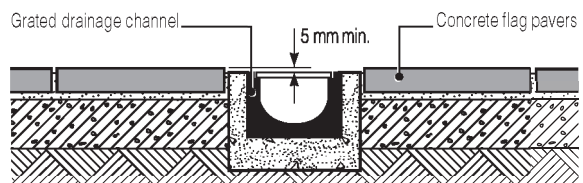

GRATED DRAINAGE CHANNEL WITH CONCRETE SURROUND

FIGURE 9 Surface Drainage Details

7.9 Bedding Sand Drainage

On wide pavements and after extended rainfall, water may penetrate the jointing and bedding courses, particularly when the pavement is new. This water can be trapped against the face of the edge restraint leading to unsightly if only temporary ponding. The bedding course can be drained either into a nearby pit or directly into subsoil drainage where provided.

Key detailing requirements are shown in Figure 10.

7.10 Further Detailing Information

The publication PA01¹⁴ *Concrete Segmental Pavements – Detailing Guide*, provides further information on laying and detailing.

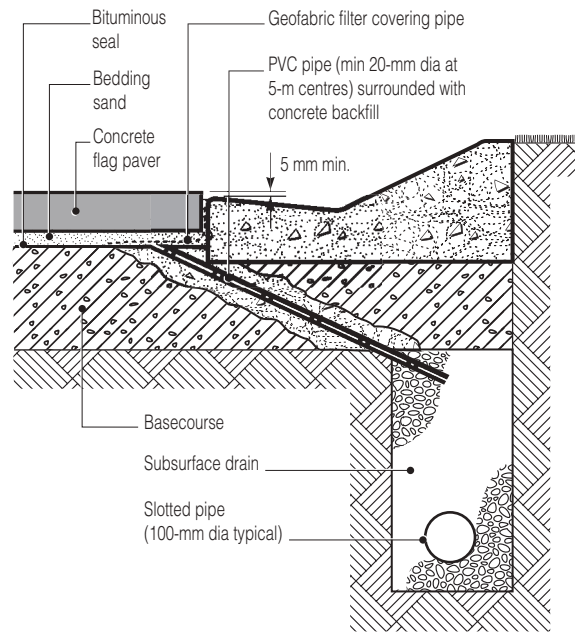

DRAINING DIRECTLY INTO SUBSURFACE DRAIN

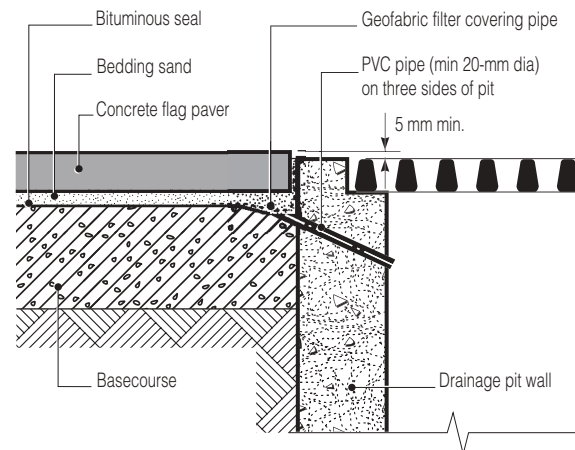

DRAINING INTO DRAINAGE PITS (ALTERNATIVE 1)

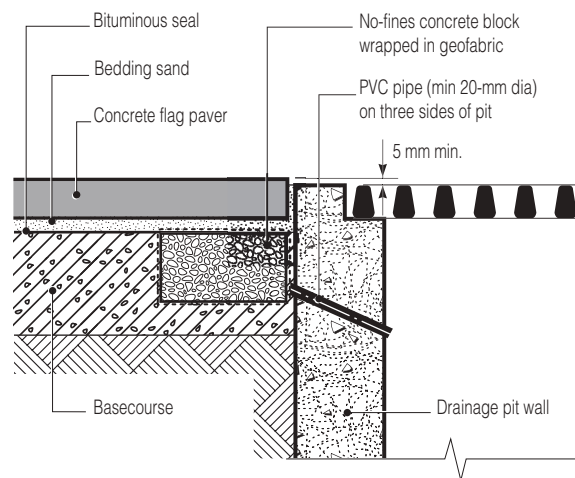

DRAINING INTO DRAINAGE PITS (ALTERNATIVE 2)

FIGURE 10 *Bedding Sand Drainage Details*

8 REFERENCES

- 1 BS 7263 *Precast Concrete Flags, Kerbs, Channels, Edgings and Quadrants*, Part 1: *Specification*
- 2 Interpave UK *Precast Concrete Paving – a Design Handbook*. UniClass E1 p225, 1999
- 3 TRL Application Guide 26 – 1997 *Footways – Design and Maintenance Guide*, Transport Research Laboratory, UK
- 4 Shackel B *Design and Construction of Interlocking Concrete Block Pavements*, Elsevier Science Publishers Ltd, 1990
- 5 Lilley A *A Handbook of Segmental Paving*, Chapman & Hall Publishers, 1991
- 6 Shackel B *Safety and Environmental Aspects of Concrete Segmental Paving*, Proceedings of Biennial Conference, Concrete Masonry Association of Australia, 1986
- 7 Pearson AR and Hodgkinson JR *A Performance Review of Concrete Segmental Pavements in Urban Redevelopment Projects*, Proceedings of Seventh National Local Government Engineering Conference, Adelaide, 1993
- 8 Shackel B *An Experimental Investigation of Factors Influencing the Design of Interlocking Concrete Block Pavements in Roads*, Proceedings of Australian Road Research Board Conference, 1982
- 9 Pearson AR and Hodgkinson JR *Some Factors Affecting Success and Distress in Concrete Segmental Pavements in Australia*, Proceedings of 4th International Conference – Concrete Block, New Zealand, 1992
- 10 Shackel B *A Pilot Study of the Performance of Block Paving Under Traffic Using a Heavy Vehicle Simulator*, Proceedings of Symposium on Precast Concrete Paving, Johannesburg, 1979
- 11 Shackel B *An Experimental Investigation of the Roles of Bedding and Jointing Sands in the Performance of Interlocking Concrete Block Pavements*, Concrete Beton No. 19, 1980
- 12 CMAA *Concrete Segmental Pavements – Guide to Specifying* (PA03)
- 13 CMAA *Concrete Segmental Pavements – Design Guide for Residential Accessways and Roads* (PA02)
- 14 CMAA *Concrete Segmental Pavements – Detailing Guide* (PA01)
- 15 AS/NZS 4455 *Masonry Units and Segmental Pavers*
- 16 AS/NZS 4456 *Masonry Units and Segmental Pavers – Methods of Test*
- 17 AS/NZS 4586 *Slip Resistance Classifications of New Pedestrian Surface Materials*.

PO Box 370, Artarmon NSW 1570 Australia
Suite 3.02, Level 3, 44 Hampden Road Artarmon NSW 2064 Australia
Telephone +61 2 8448 5500 Fax +61 2 9411 3801
ABN 30003873309

www.cmaa.com.au

