

A STEP-BY-STEP GUIDE TO **PERFECT PAVING**



INTRODUCTION

Flexible concrete block paving is a pavement structure that maintains contact with and distributes loads to subgrade. The base course relies on aggregate interlock, particle friction and cohesion for stability. Where required, soil stabilisation may be used.

Advantages of using concrete pavers include:

- Standard sizes are available, with tight length, width and height tolerances
- Aesthetics: shapes, colours, textures
- Easy to cut
- Do not shrink
- Give good traction

Once laid, concrete pavers are:

- Dense and durable
- Able to withstand severe weather and heavy loads without losing colour or structural integrity
- Easy to clean
- Relatively easy to remove to improve drainage or repair utilities below pavers

For more detail on laying paving, see SANS 1200-MJ:1984 Standardized specification for civil engineering construction - Laying of paving

SABS-approved pavers and kerbs:
SANS 1058:2012 ed 2.1 Concrete block paving
SANS 927:2007 Precast concrete kerbs, edgings and channels



Concrete Manufacturers Association
16 Horn Street, Chloorkop, Kempton Park
Tel: 011 805 6742 • Fax: 086 524 9216
e-mail: admin@cma.org.za • Website: www.cma.org.za

CONTENTS

Step 1: Ordering materials	4
Step 2: The right tools for the job	8
Step 3: Site preparation.....	14
Step 4: Laying edge restraints or kerbs.....	20
Step 5: Placing bedding sand.....	24
Step 6: Laying pavers and compacting	28
Step 7: Placing jointing sand	37
Step 8: Maintenance.....	41

Editor: John Cairns, JC Paving

Illustrator: Anne Jonker-Colley

Published on behalf of the CMA by:

Isikhova Publishing & Communications CC
PO Box 651793, Benmore, 2010, Johannesburg, South Africa
27 Panners Lane, Riverclub, Sandton, South Africa
Website: www.isikhova.co.za

Layout: Joanne Brook

Printer: The Bureau

Copyright protected. No unauthorised copies in any format to be produced without written permission from the CMA.

OVERVIEW OF PAVING PROCESS

STEP 1: **Materials**

STEP 2: **Tools**

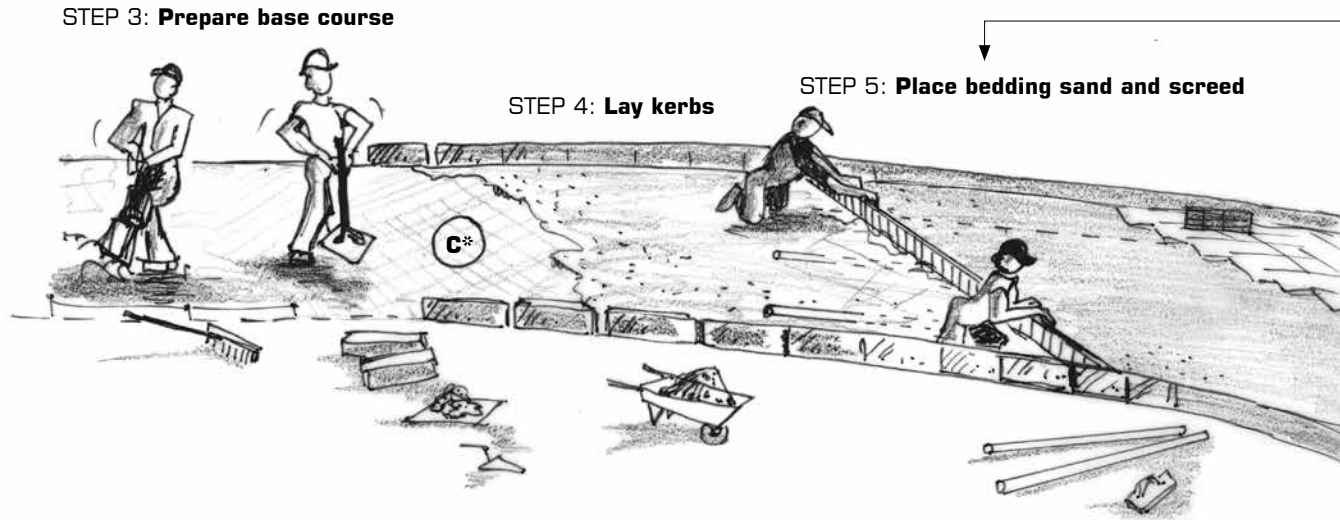

STEP 3: **Prepare base course**

STEP 4: **Lay kerbs**

STEP 5: **Place bedding sand and screed**

C* Check levels

C** Check lines, patterns and individual block levels

Set out — Excavate — Level — Stamp —————> Lay kerbs —————> Place bedding sand —————> Screed —————>

Must complete steps 5,6 and 7 in one day

STEP 6: Lay, compact pavers

Start at lowest level, move up the slope

STEP 7: Place jointing sand

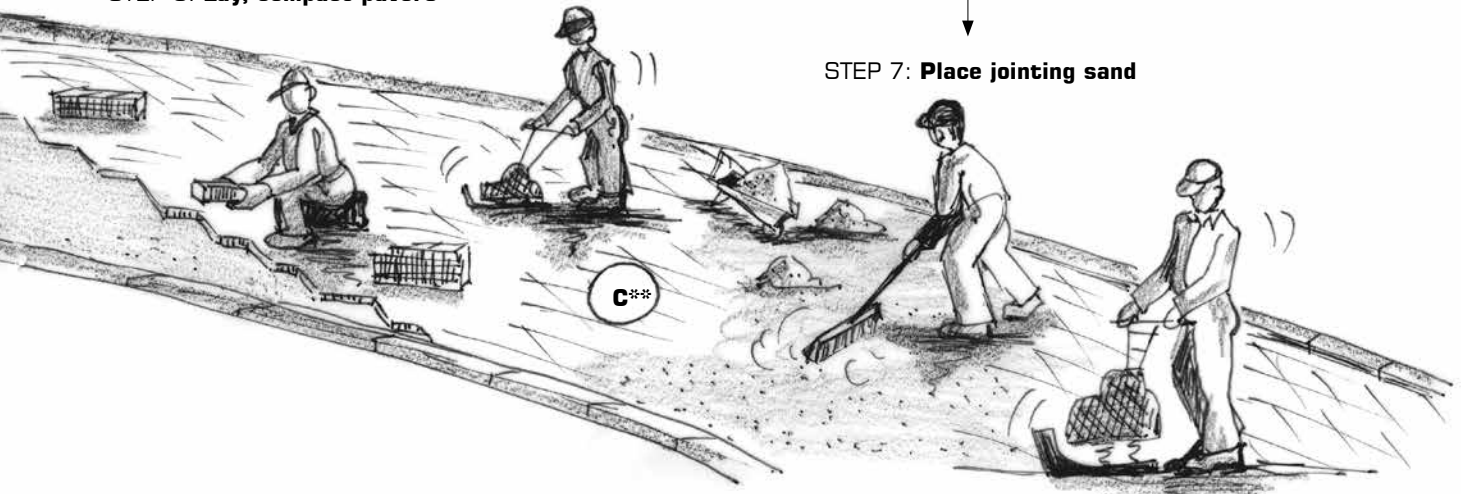

Smooth

Lay pavers

Compact

Sweep in jointing sand

Compact

STEP 8: Maintenance

1.1 Chosing the right pavers for the application

The pavers must be strong enough for the application, eg. foot or domestic traffic, heavy duty transport

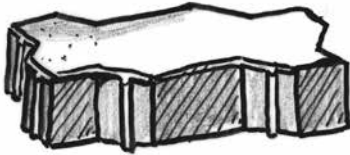

Interlocking pavers give better performance under heavy traffic



Dimensional tolerances:

- Length and width: $\pm 2\text{mm}$, height: $\pm 3\text{mm}$
- Spacers or lugs: not more than 3mm

SABS-approved pavers recommended

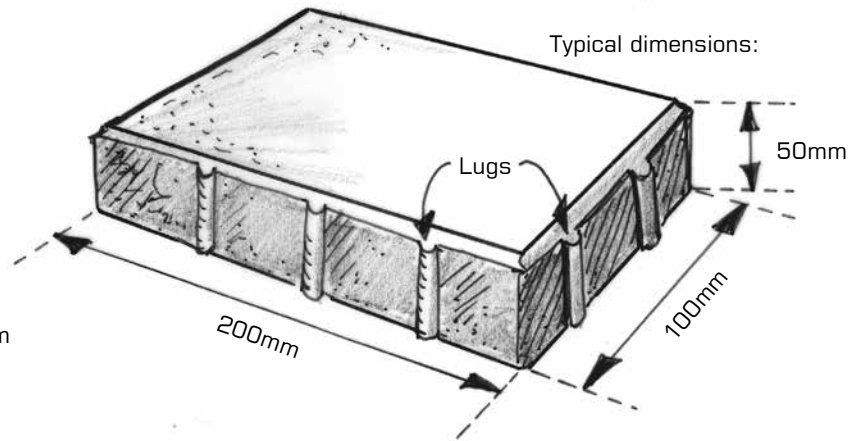
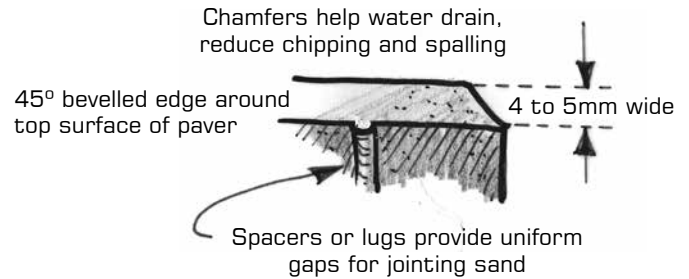

1.2 Calculating paver quantities

Pavers are sold per square metre (m²)

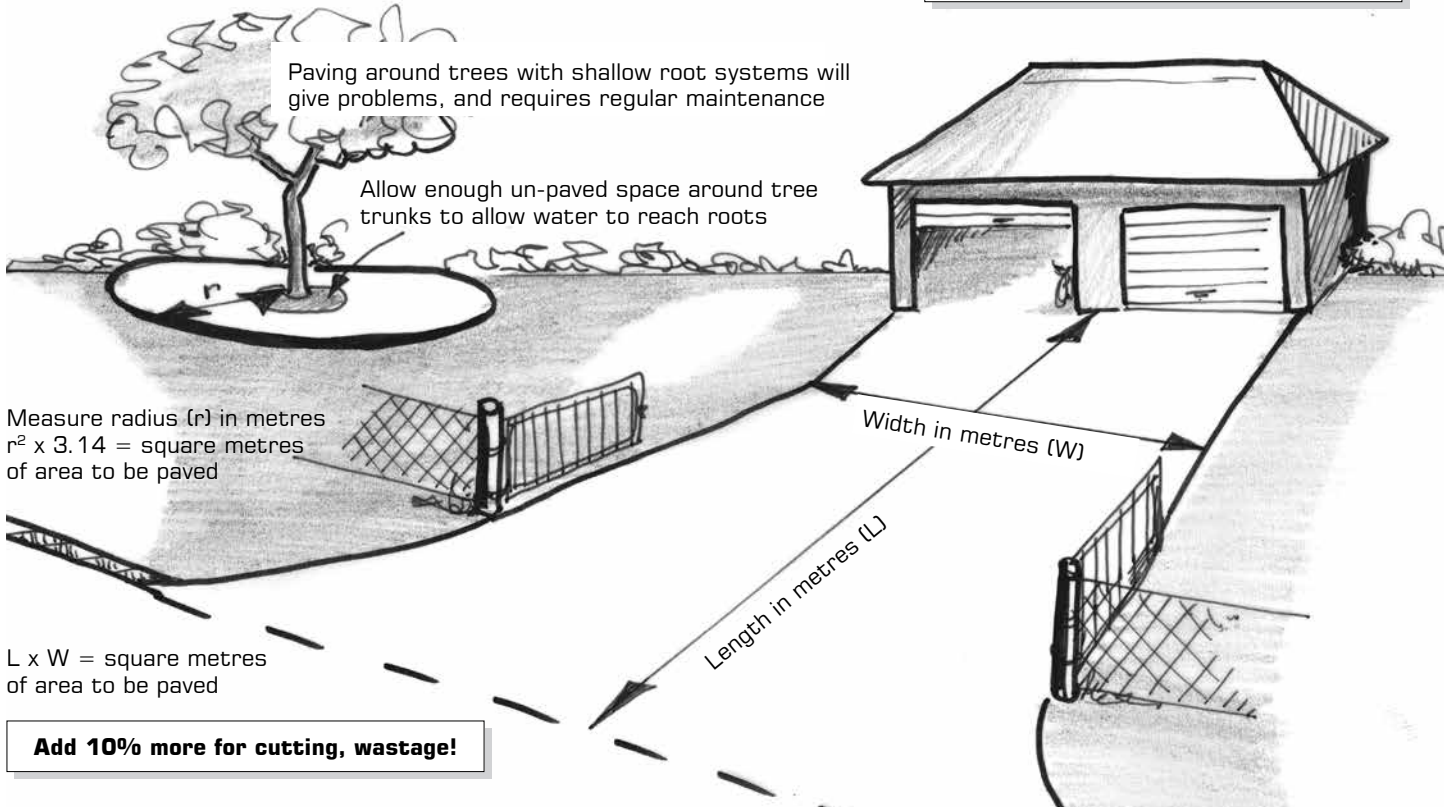

1.3 Choosing edge restraints

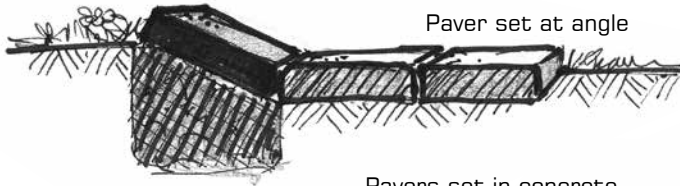

Kerbs can be exposed or hidden but are essential to stop paving from spreading and losing interlock.

Match type of edge restraint to type of traffic

Pavers set in concrete act as kerbing

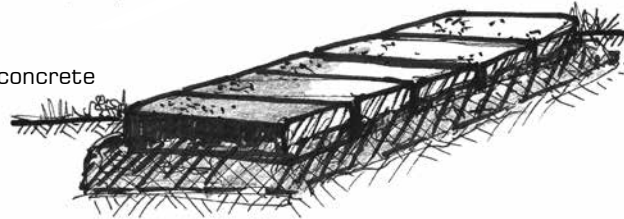

Length of unit

Heavy-duty (HD) kerbs

Measure total length of edging around paved area:

$$\text{Number of units} = \frac{\text{Total length of edging, m}}{\text{Length of kerb unit, m}}$$

Light-duty (LD) kerbs

Add 10% more for cutting, wastage!

SABS-approved kerb units recommended

Mountable kerbs

1.4 Ordering bedding and jointing sand, cement

Bedding sand

Always use good quality well-graded washed river sand, \pm 6 to 7% moisture.

Order 2.5m^3 of bedding sand per 100m^2 of paving.

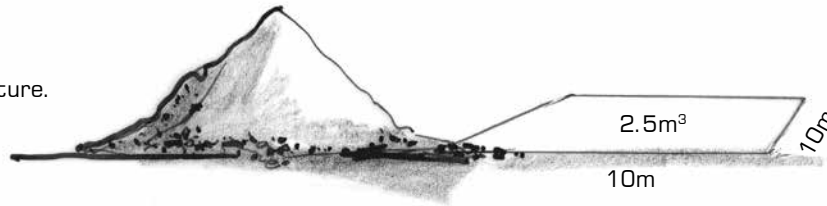

Jointing sand

Use fine plaster sand, 100% dry.

Order approximately 10% of bedding sand.

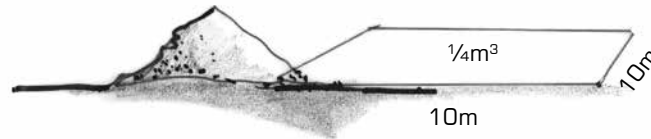

Cement

Only required for concreting kerbs, or for subgrade stabilisation.

Use general-purpose (CEM II or CEM III) cement with SABS mark

For subgrade stabilisation, order 1.5 bags (75kg) per m^2

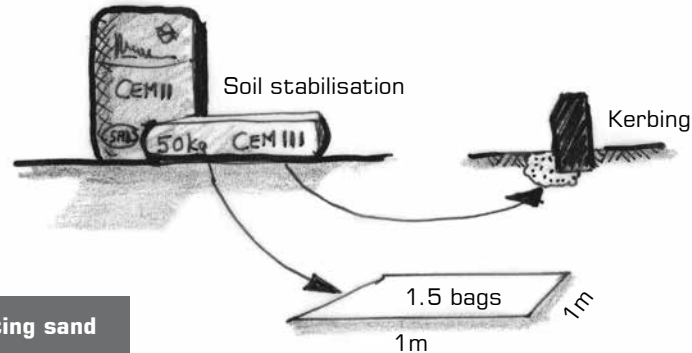

NEVER add cement to bedding or jointing sand

STEP 2: THE RIGHT TOOLS FOR THE JOB

2.1 Setting out

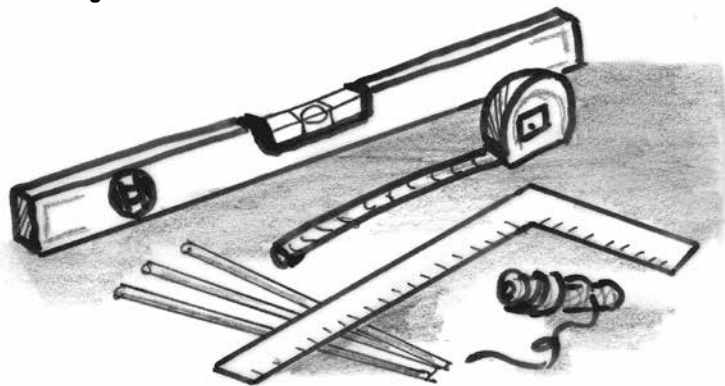

Spirit level, tape measure,
carpenter's square, stakes, string line

2.2 Excavating

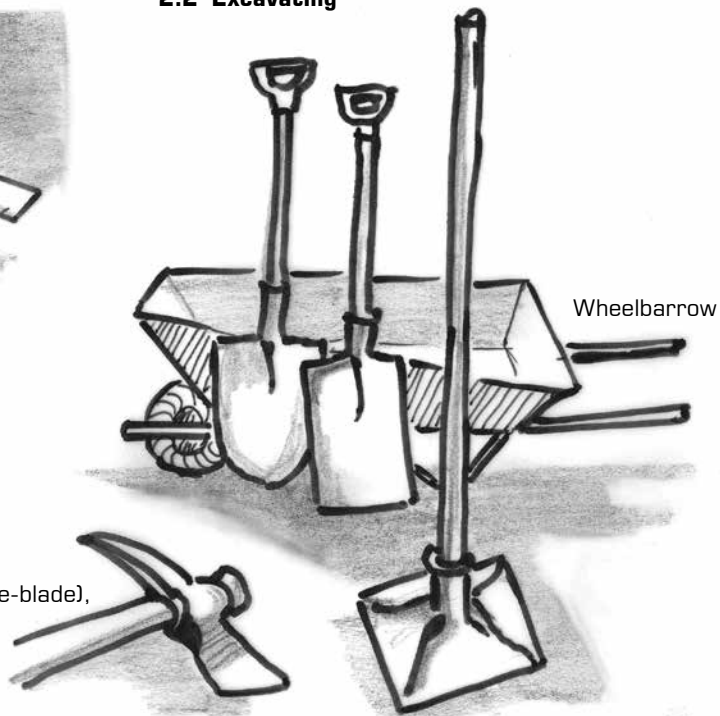

Shovel (round-nose), spade (square-blade),
hand tamper, pick

2.3 Base course and paver laying

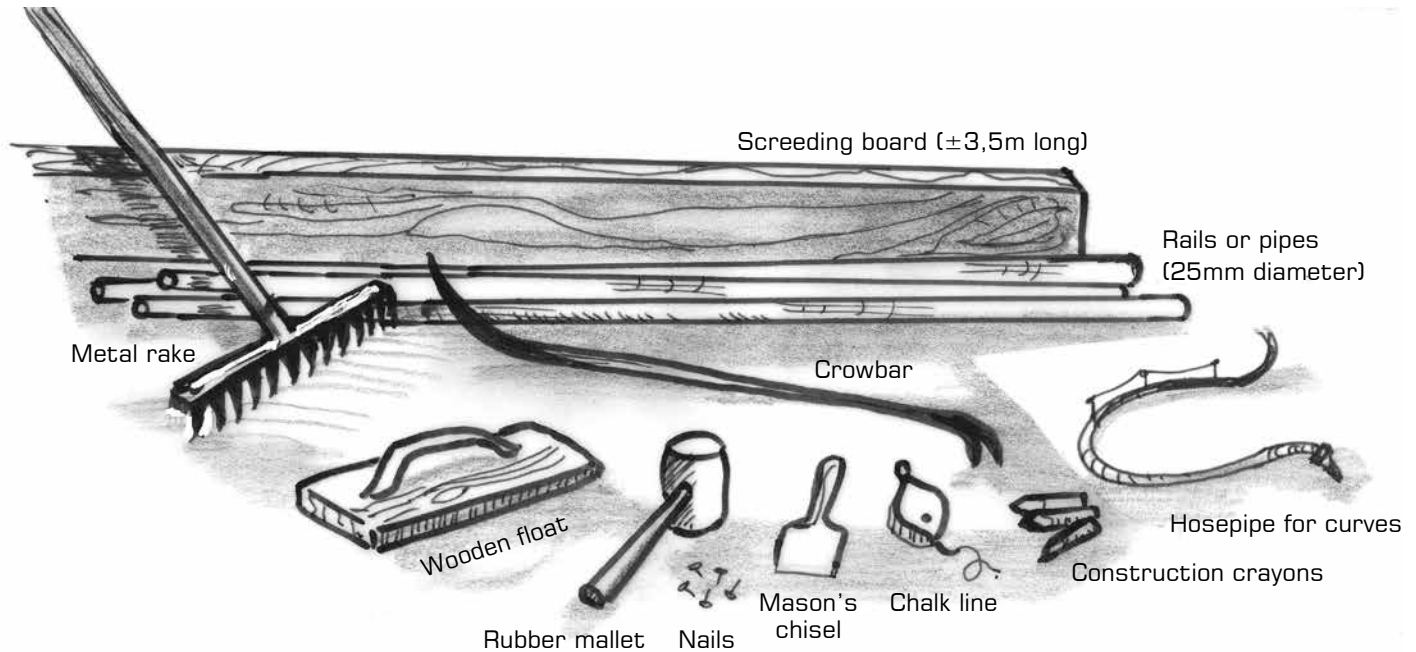

2.4 Paver cutting

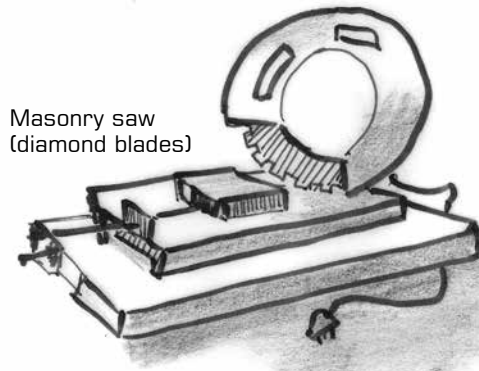

Masonry saw
(diamond blades)

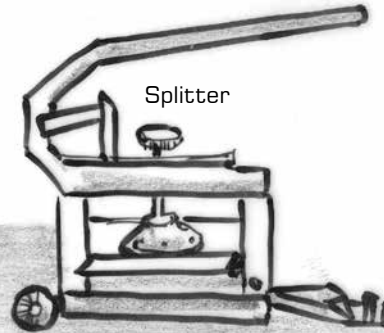

Splitter

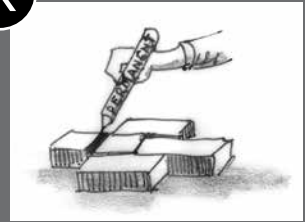

Permanent marker
IS permanent

2.5 Paver handling



Paver cart: best practice

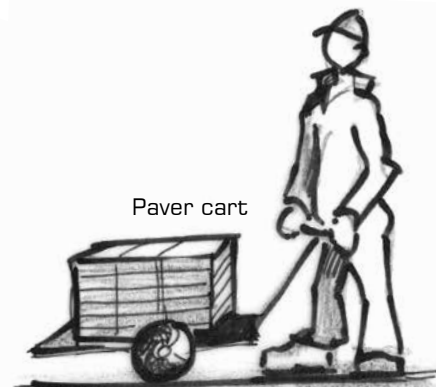

Paver cart

Stack neatly to avoid damaging pavers

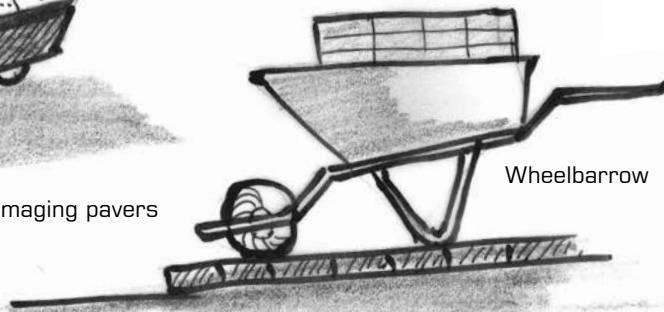

Wheelbarrow

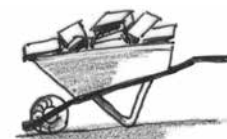

NOT good practice:
broken pavers, corners

2.6 Mechanical equipment

Jumping jack tamper for compacting base course

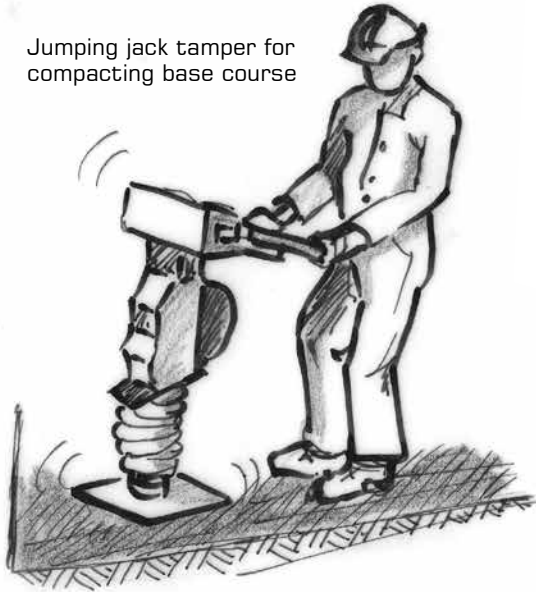

2.7 Finishing

Stiff-bristled broom



Plate compactor or vibrator for compacting pavers

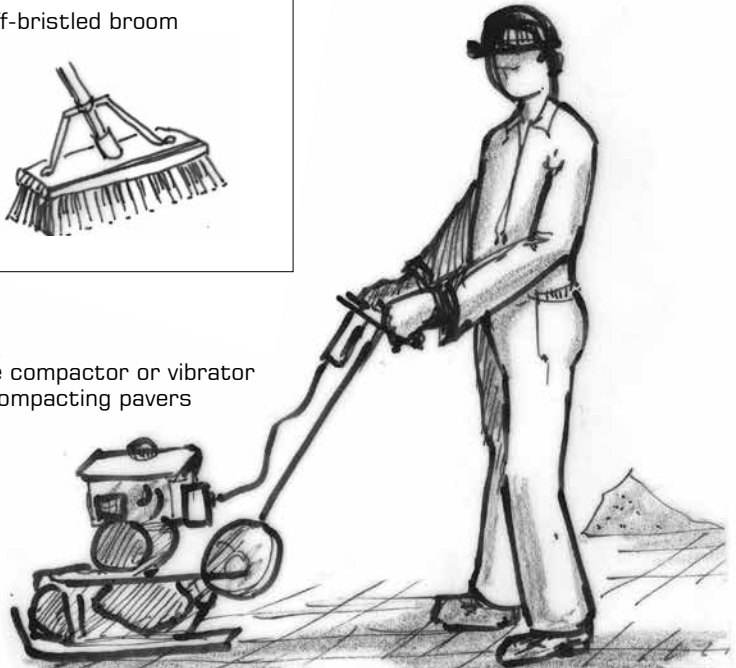

2.8 Safety equipment

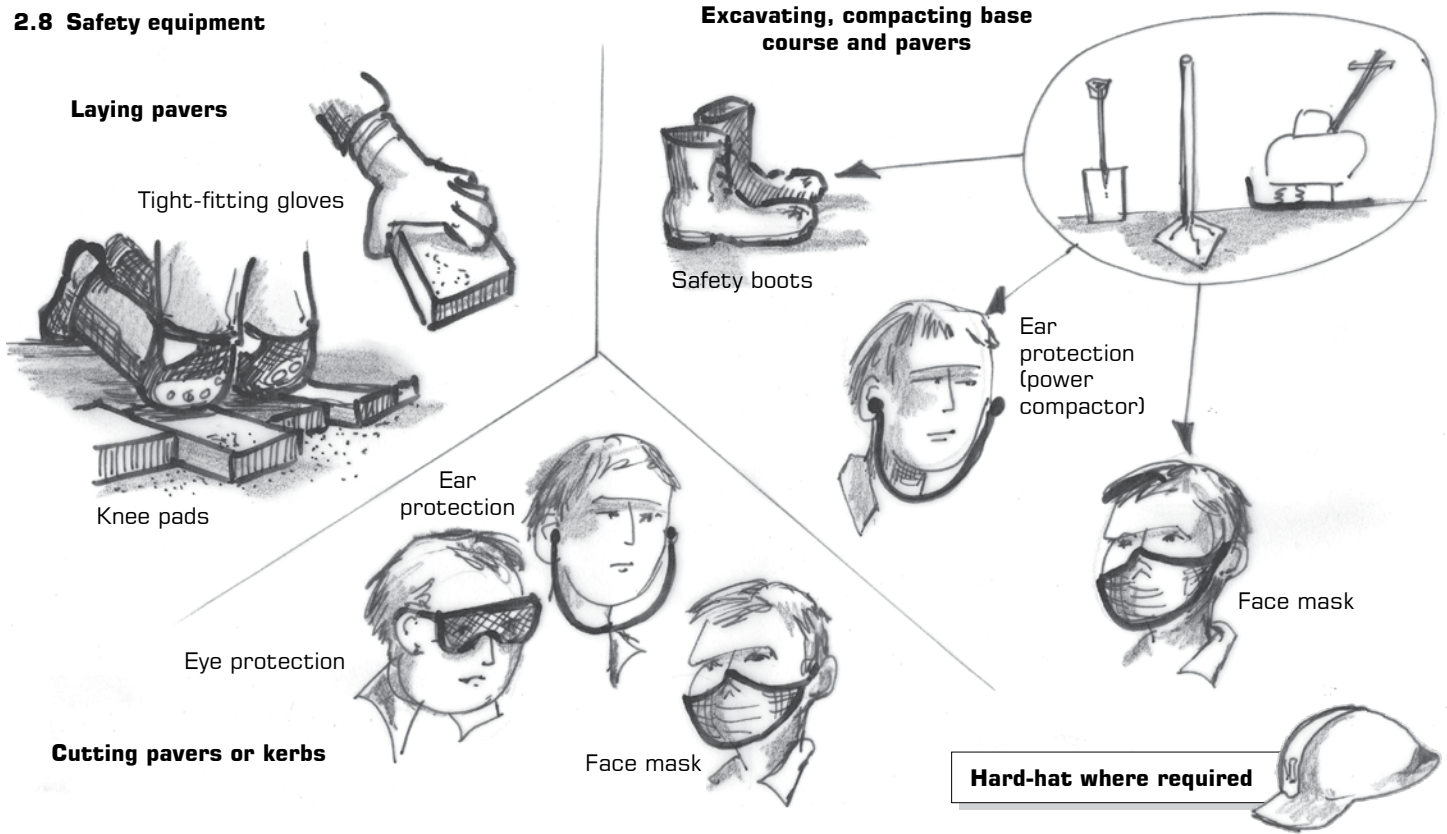

3.1 Site inspection

Slope paving **away** from garage floor level

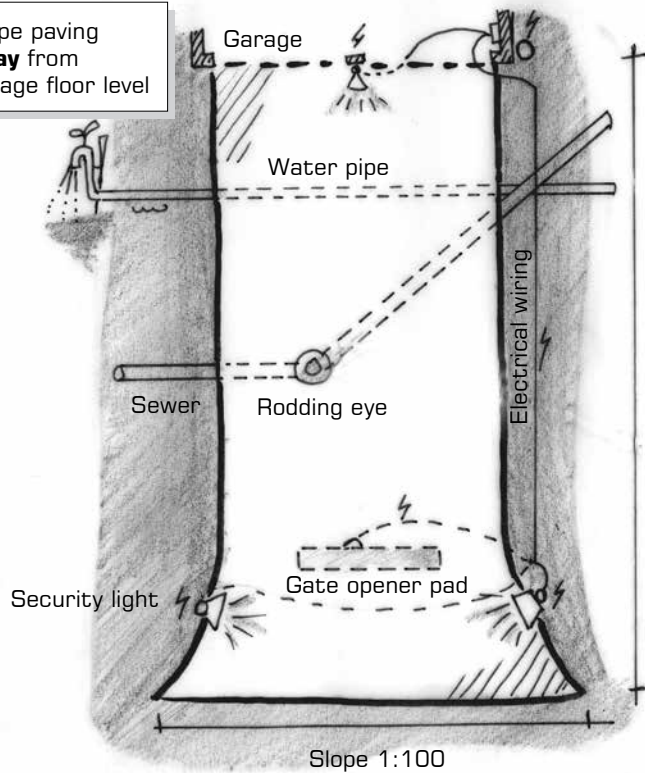

Slope 1:50

Check slopes, levels

Minimum slope of 1 in 50 in one direction,
1 in 100 in the other to ensure water run-off

X Don't guess where underground utilities are!

Mark existing utilities on plan to avoid damage to water pipes, electrical wiring, communication lines, sewers during excavation, compaction, etc

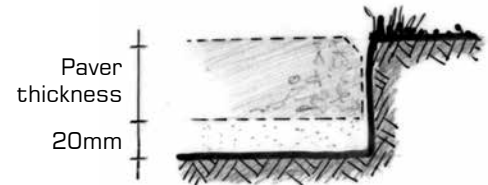

Finished base level:

20mm + paver thickness
below finished level
ie. 25mm damp bedding sand
will compact to ±20mm

3.2 Checking slopes and drainage

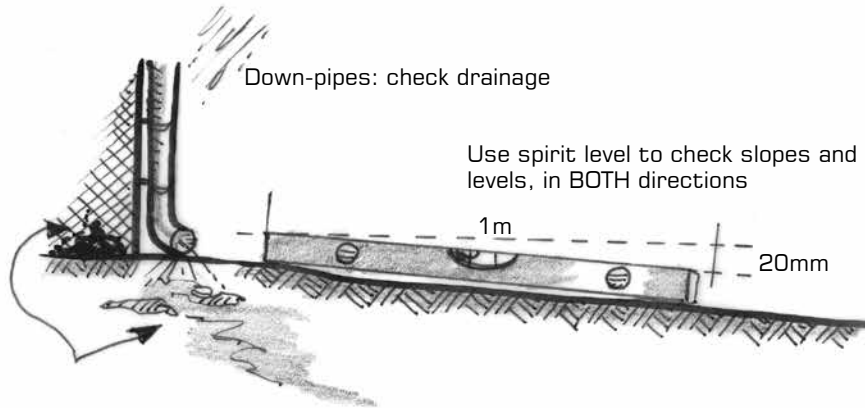

Extra drainage required?

Large volume of stormwater runoff, muddy areas, persistent puddles, lush vegetation, wet basement walls, rising damp?

Check "drainability":

- Dig 30 x 30cm hole, 60cm deep
- Fill with water
- Allow to drain, fill again

After 24 hours: no water? Soil is porous enough.

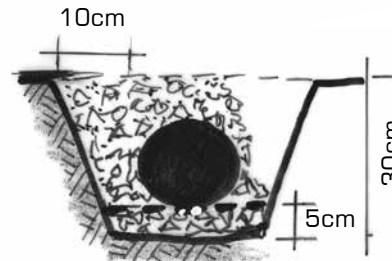

Don't lay pipes in wide shallow trenches

Don't cover pipes with loose sand

After 48 hours: standing water?

Improve drainage

- Dig 30cm deep trench, 10cm wider than pipe, slope 10mm per metre
- Lay 5cm gravel in bottom of trench
- Lay perforated PVC agricultural drainpipe, wrapped in bidum to stop sand/root blockage
- Cover pipe with gravel up to base course level

3.3 Setting out

Perfectly square corner

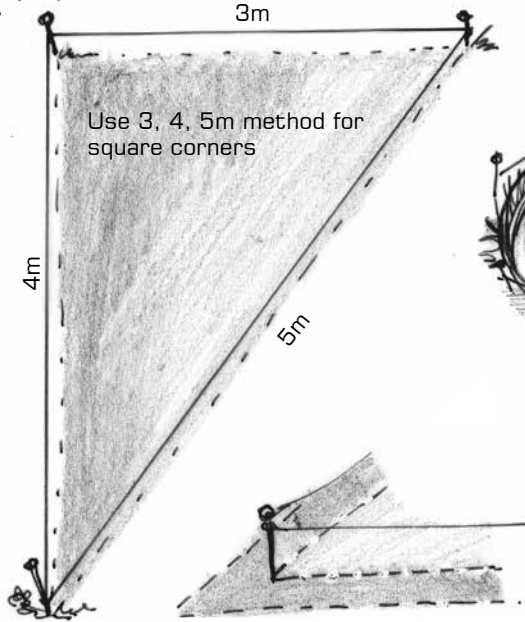

Use 3, 4, 5m method for square corners

Add extra width if edge restraints will be concreted in

Clear vegetation, check levels again, mark out where paving will go

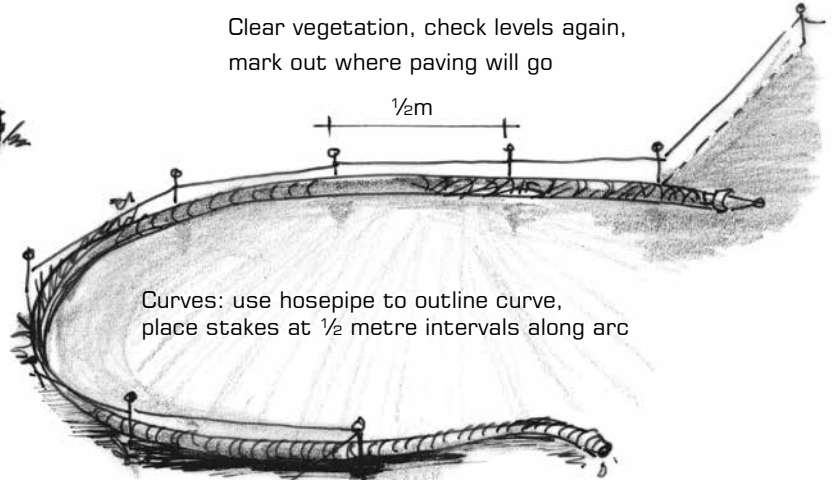

Curves: use hosepipe to outline curve, place stakes at 1/2 metre intervals along arc

Opposite sides parallel?

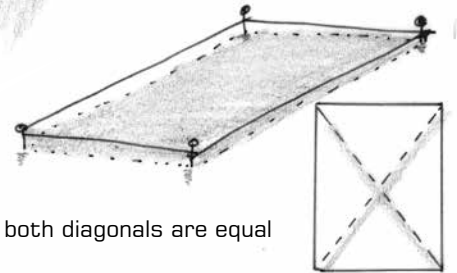

Yes if both diagonals are equal

3.4 Base course

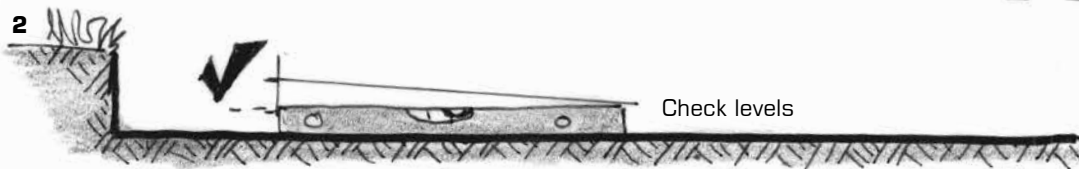

3.4 Base course

3

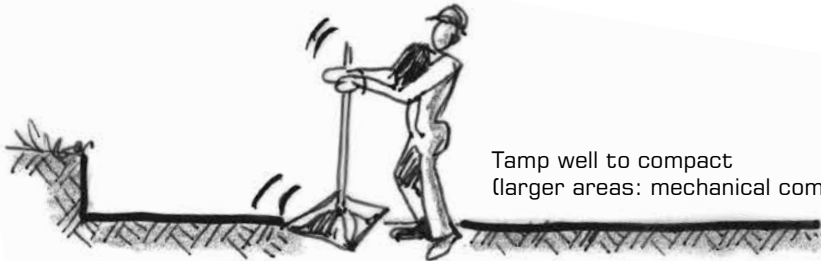

Tamp well to compact
(larger areas: mechanical compactor)



Base uneven, not well-compacted?
Paving will take up same contours!

4

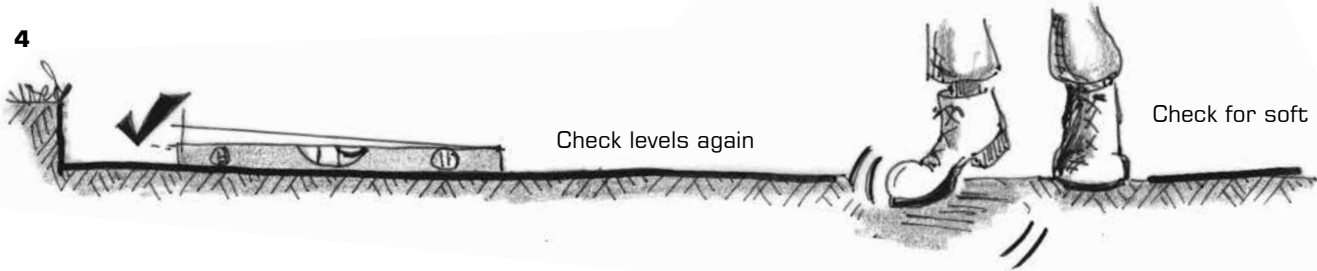

Check levels again

Check for soft spots

3.5 Base stabilisation

Why stabilise base course?

- Improve, densify poor subgrade
- Specified by engineer
- Trafficking by heavy vehicles
- Around fixtures, manholes, drains, etc.

1. Spread dry cement evenly over surface
2. Dig in using TLB or spades until no grey streaks are evident
3. Compact using hand tamper or mechanical compactor as soon as possible after mixing in
4. Sprinkle with water (moist, not soggy) to activate cement hydration

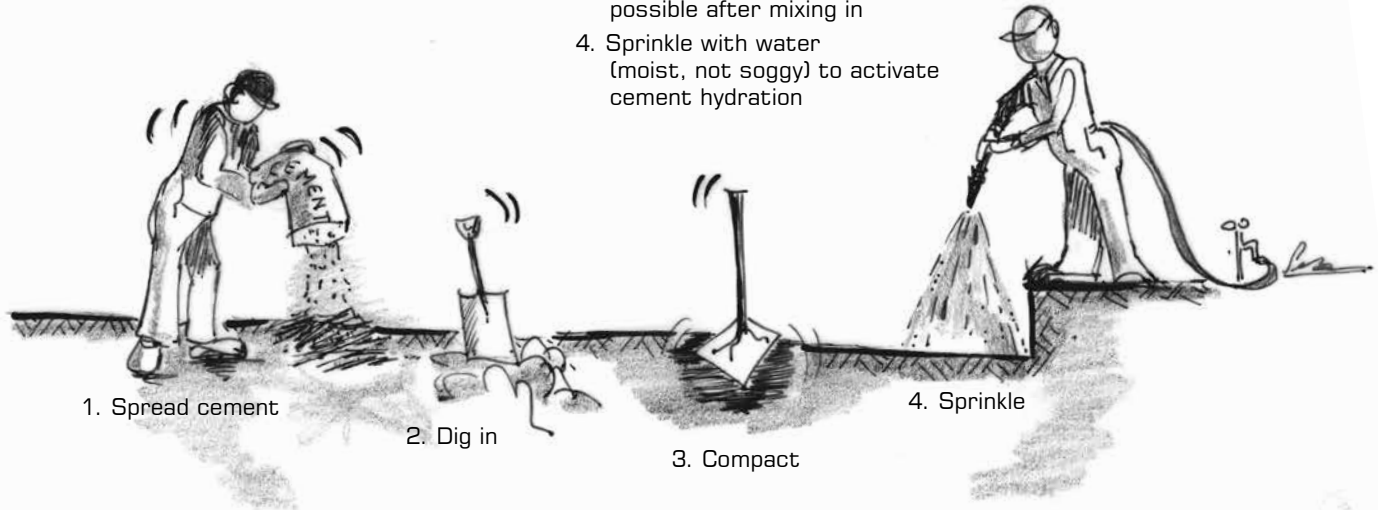

STEP 4: LAYING EDGE RESTRAINTS OR KERBS

4.1 Kerbing options for HD and LD applications

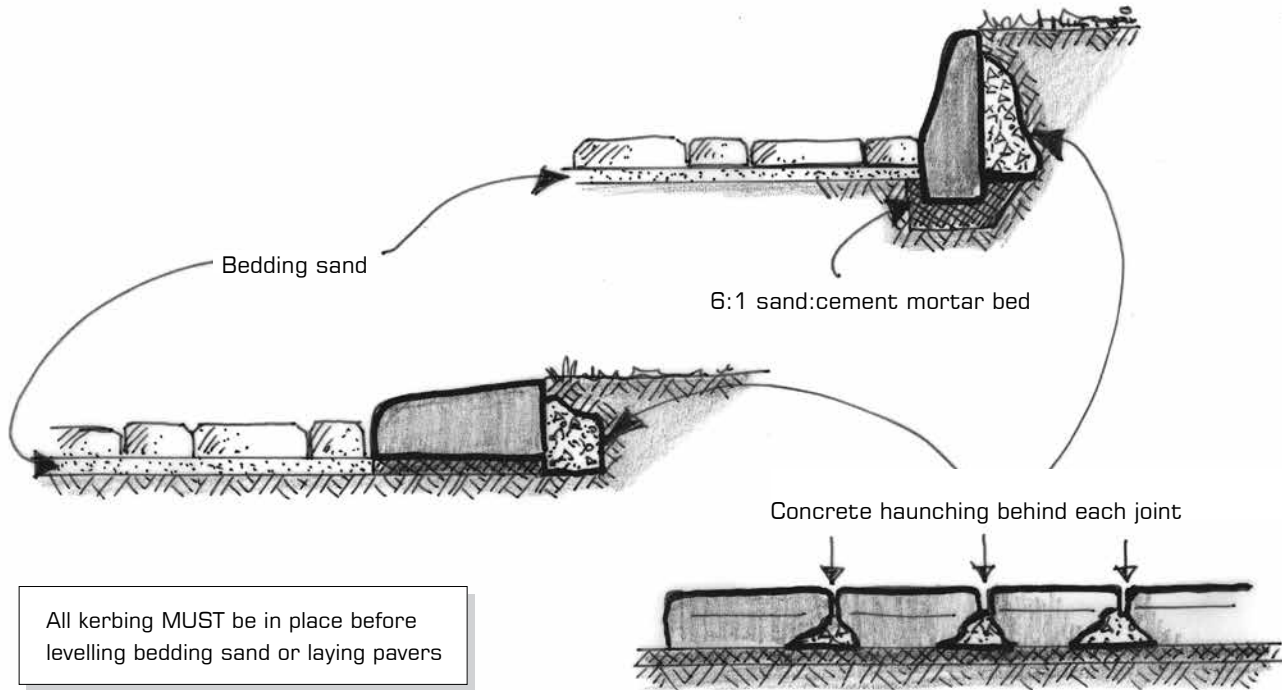

4.2 Kerbing options for garden paths and landscaping

Hidden restraint; first paver concreted into place

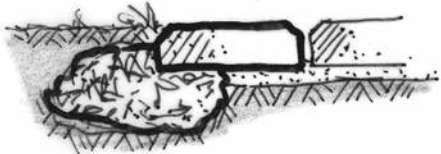

Hidden restraint



Paver or kerb laid on edge into concrete

Kerb level with paving

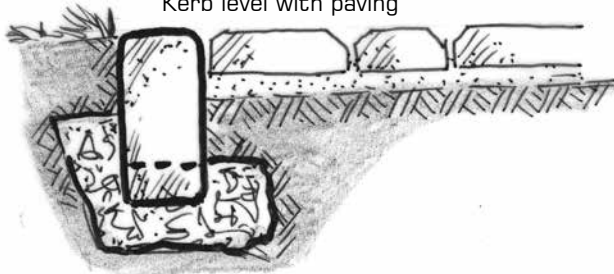

Ride-over edge



Kerbs are always required, even in NO TRAFFIC situation

4.3 Existing building walls as edge restraints

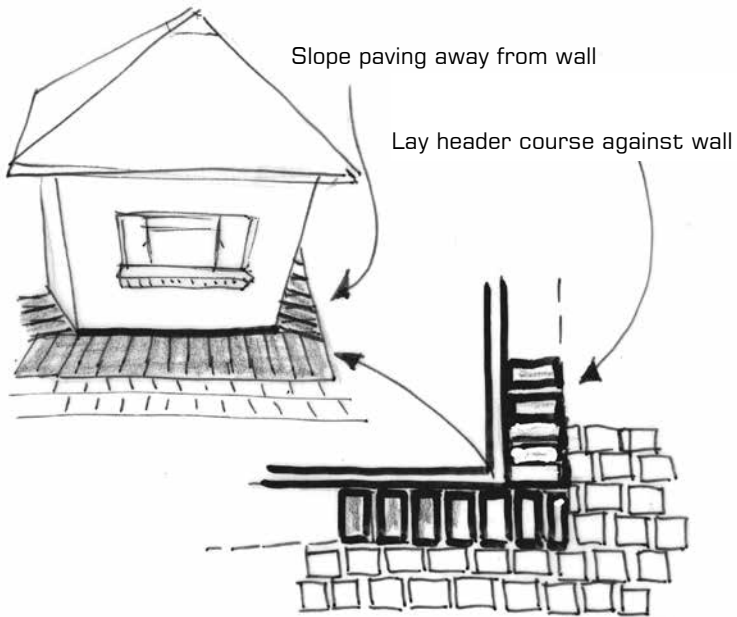

No kerbing is required where walls act as edge restraints

Why does paving need edge restraint?

No edge restraint:

- Pavers move apart
- Structural integrity is breached

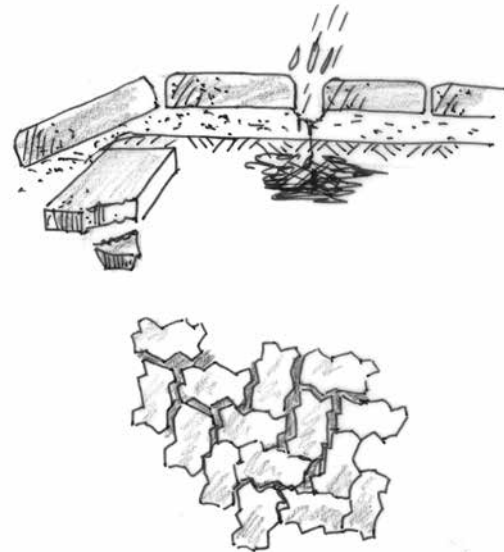

4.4 Placing kerbs

- Place 7 to 10cm layer concrete/dagha on outer edge
- Lay kerb unit into wet concrete/dagha
- Use dagha to fill gaps between kerb units

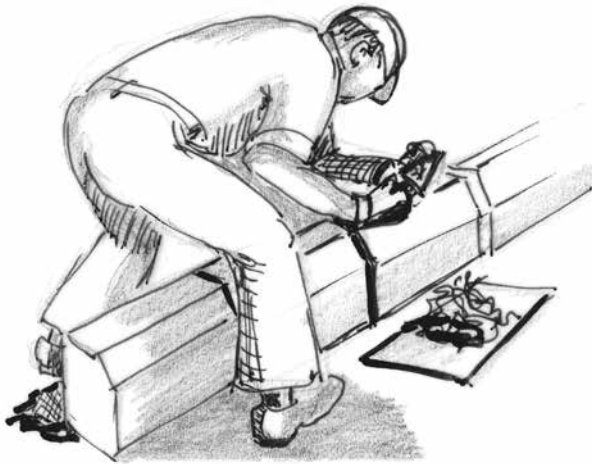

Use rubber mallet to tap units firmly into place, backfill, tamp until pavers are stable

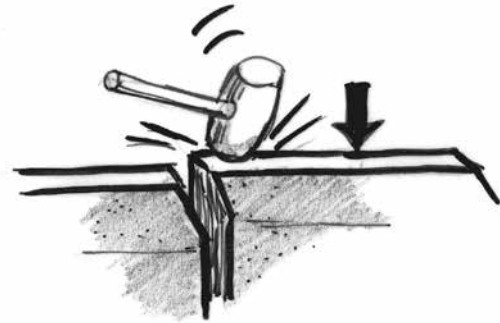

Check that tops of kerbing units are level

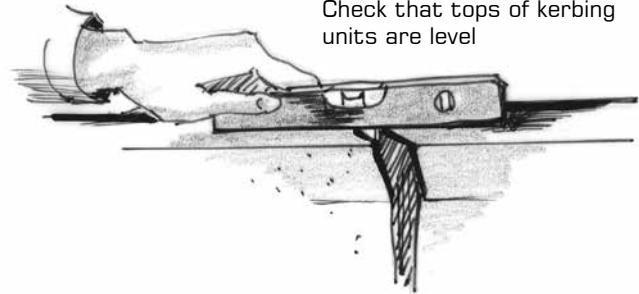

5.1 Placing rails

Use rails (or pipes) to ensure even thickness of bedding sand.

- Lay rails on subbase, screed-board length (3m) apart
- Use screed-board to pull bedding sand until thin line shows (top surface of rail)

Typical bedding sand layer:
25mm uncompacted
(Compaction typically
reduces this to $\pm 20\text{mm}$)



Don't use plastic sheeting. Placing bedding sand on plastic:

- Badly affects particle interlock, base structure
- **DOES NOT** stop weeds from growing
- Stops water from draining through paving



5.2 Bedding sand moisture content



Quick moisture content check:

Squeeze a fistful of sand



Open your hand:

Moisture is correct if
sand forms a cohesive ball

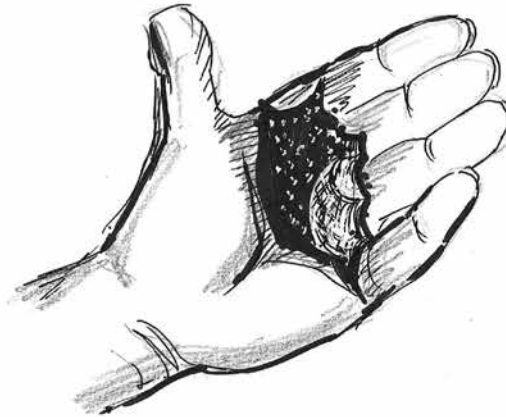

Bedding sand must not be TOO DRY (sand particles fall apart) or TOO WET (moisture squeezes out between fingers)



5.3 Levelling off bedding sand

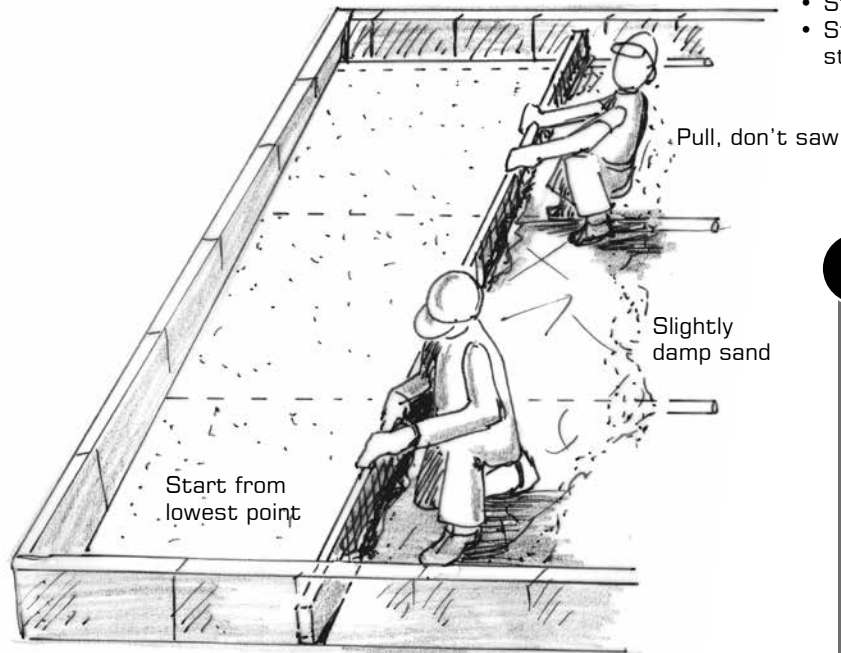

Screed board must be:

- Good quality timber
- Straight, not bowed
- Strong enough to remain straight under pressure of sand

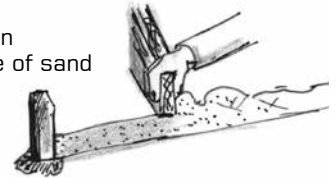

Start screeding from lowest point, move UP the slope

X

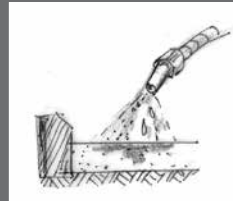

Don't:

- Add cement to bedding sand
- Compact bedding sand layer
- Add extra water before/after placing

Use screed board to pull sand into place, level surface

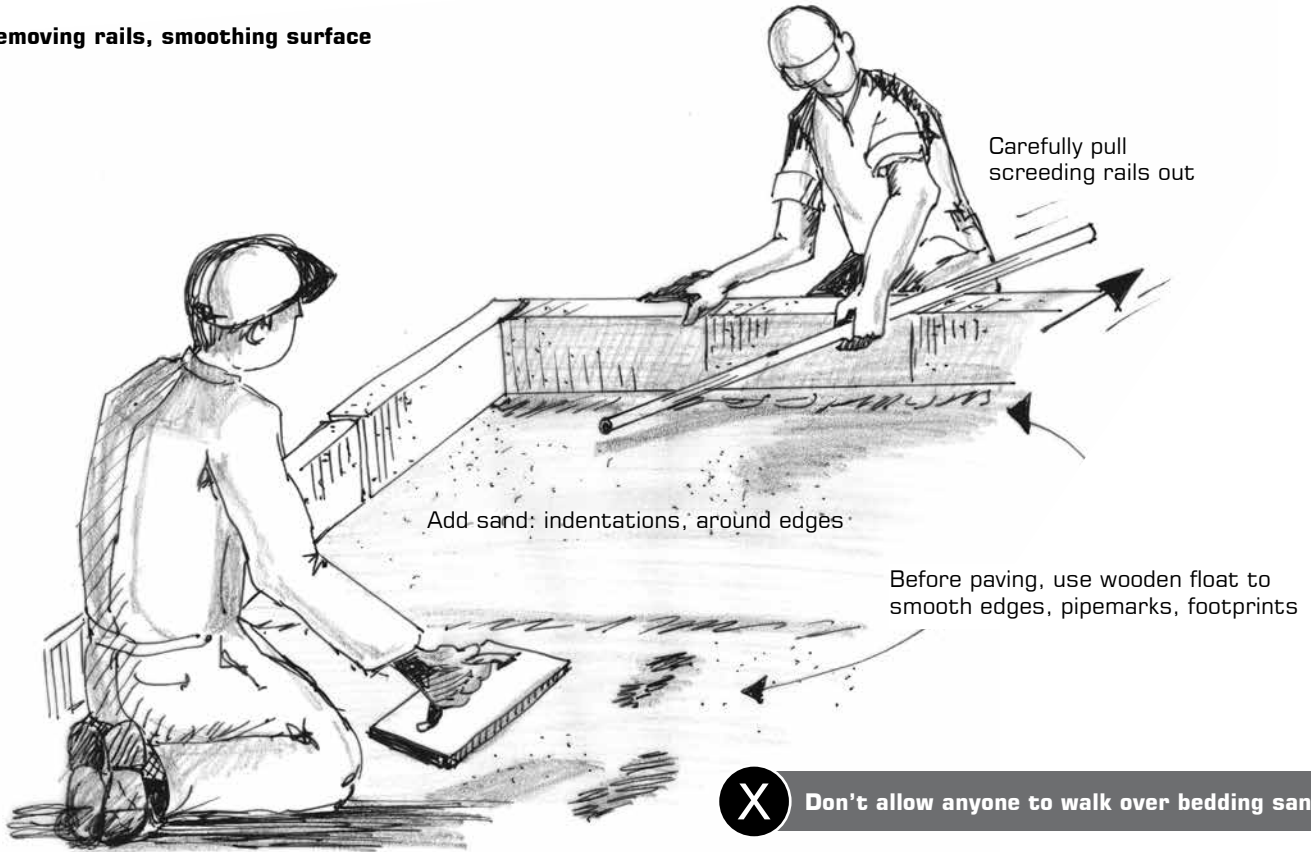
5.4 Removing rails, smoothing surface

6.1 Laying patterns

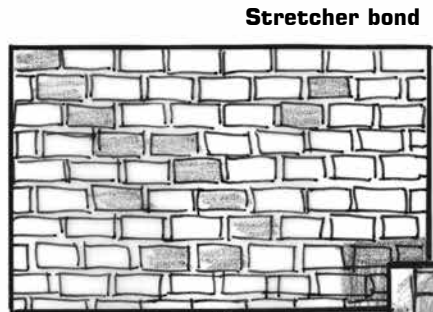

↑
Direction of traffic

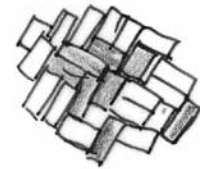
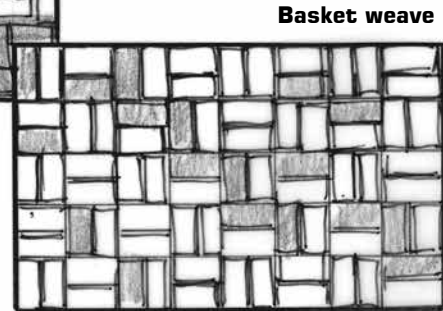
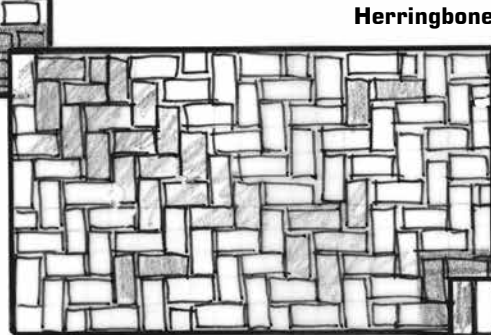

**Don't mix patterns,
choose one and
stick with it!**

6.2 Header course and starting the pattern

Start laying header course (if required) first

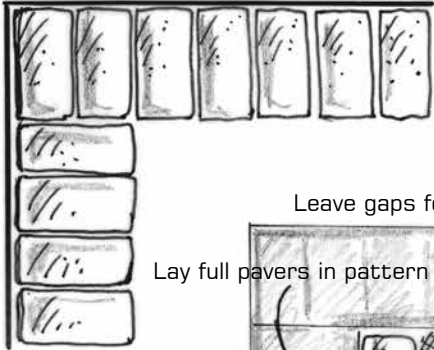

Start paving from lowest point, work uphill



Leave gaps for cut pavers; cut, place later

Lay full pavers in pattern

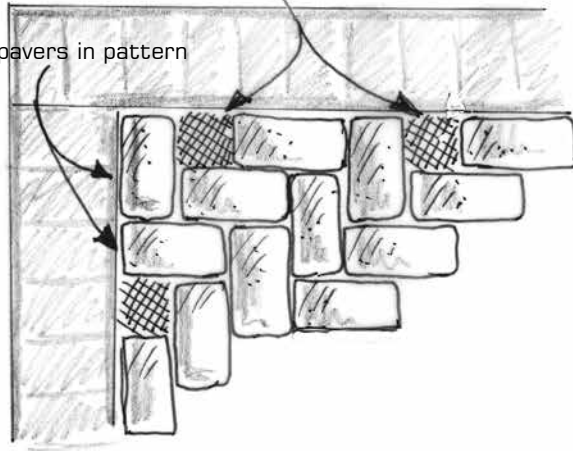

Full and cut pavers: 3 to 4mm joint all around
No paver touches any adjacent paver

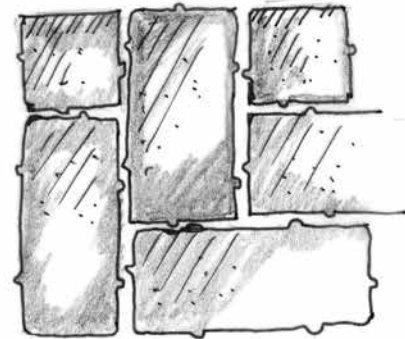

6.3 Laying pavers

Cut X into top surface of paver above rodding eye, etc

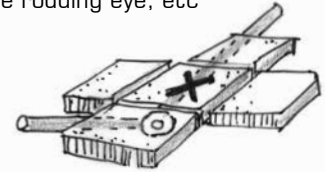

Stack pavers within easy reach for efficient paving



Don't stand on laying edge

6.4 Marking pavers for cutting

X Don't cut pieces smaller than 25%

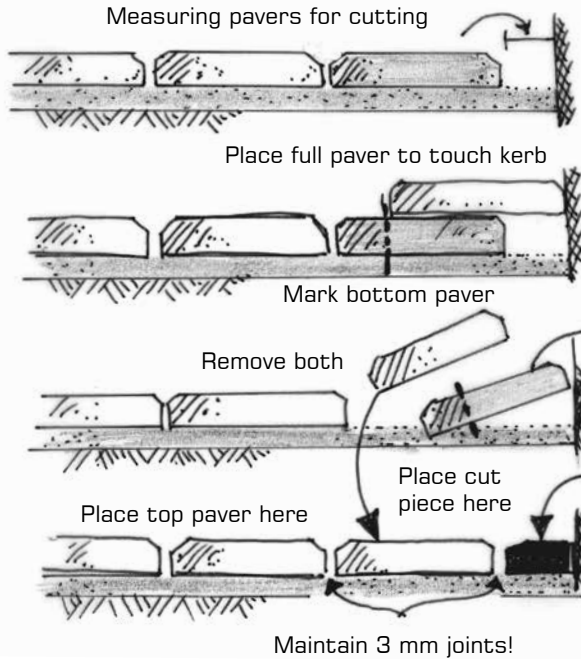

Place hosepipe where curve is to go

Mark pavers using hosepipe as guideline

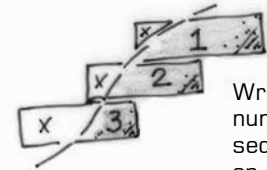
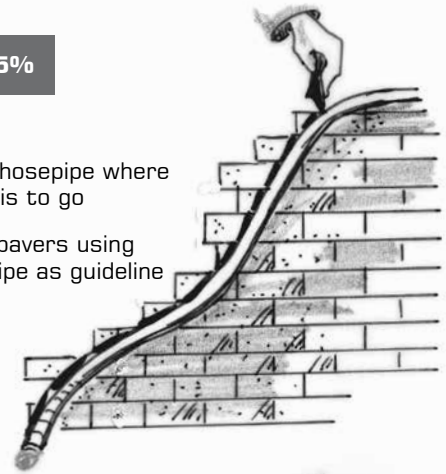

Write number in sequence on piece to be placed

6.5 Cutting and fitting edge pieces

Keep up with main pavers!

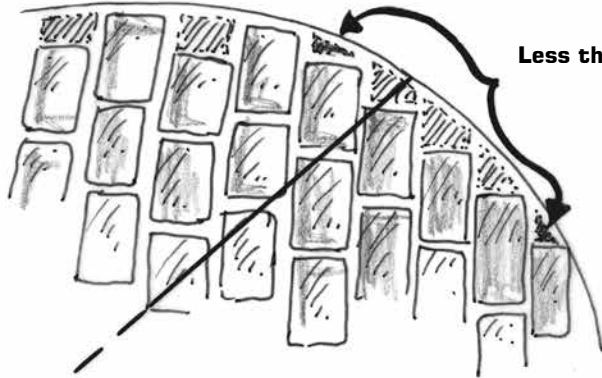

Less than 1/4 paver?

Where joint is required right across paving, use masonry saw AFTER laying

Header course

Double-cut pavers to avoid narrow slivers

Cut two width-way pavers rather than one length-way unit

Double cut

Edge restraints

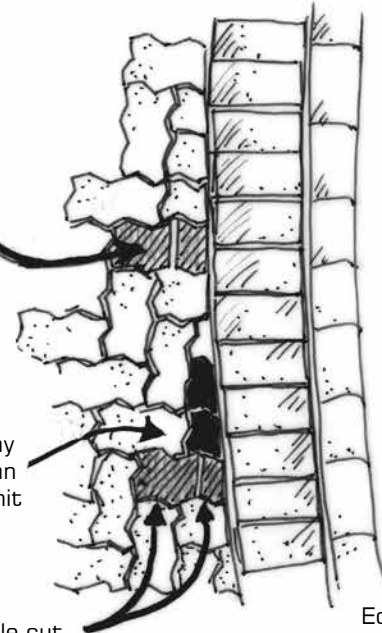

6.6 Cutting pavers to a curve

Pavers laid in concrete as edge restraint

Alternate cut and non-cut units for smoother edge

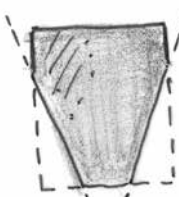
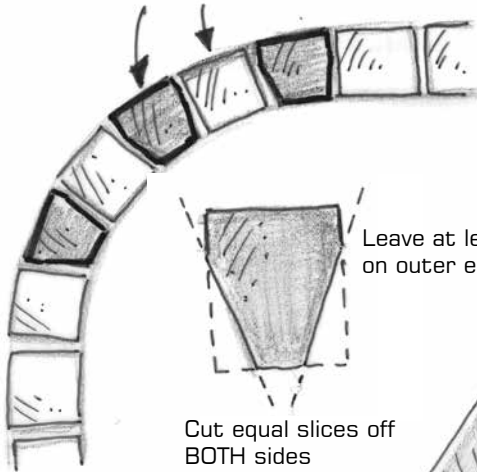

Leave at least 10 mm on outer edge uncut

Cut equal slices off BOTH sides

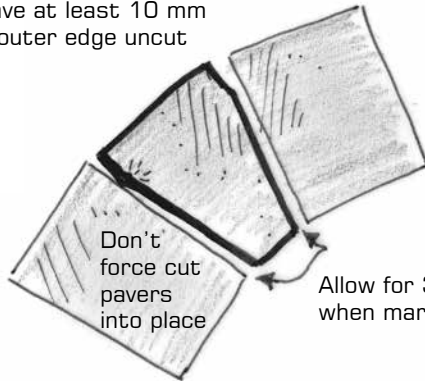

Don't force cut pavers into place

Allow for 3mm joint when marking

Depending on paver size and radius of curve, you may need to cut every paver

Pavers used as header course

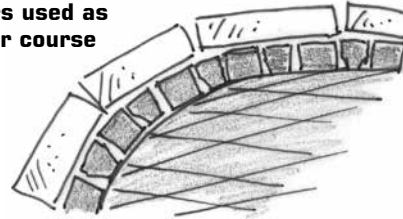

Don't cut slivers

6.7 Initial compaction



Sweep all debris from pavers before compaction

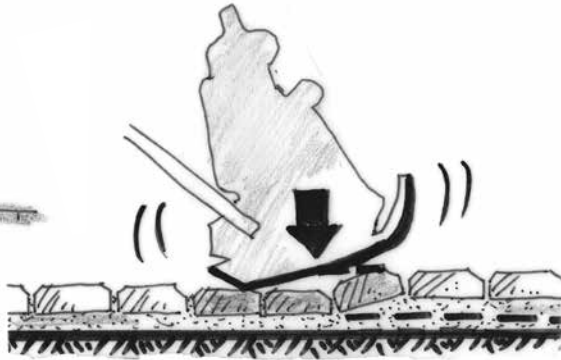

Use mechanical compactor to vibrate pavers into bedding sand, level surfaces

To avoid damaging textured pavers, fix conveyor belting onto vibrating plate before compacting

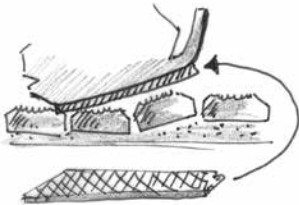

Keep compactor at least 1.5m from laying edge

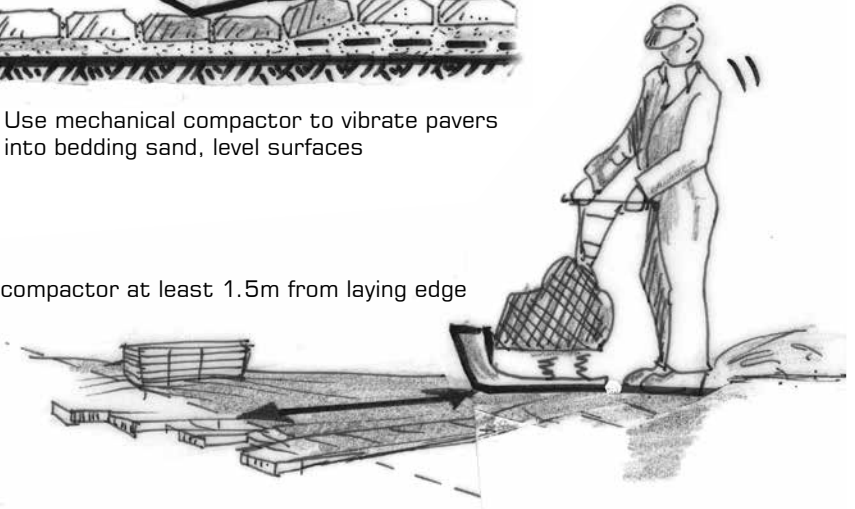

6.8 Checking pavers after initial compaction

Check pavers; mark broken/chipped and high/low pavers. Wait till compactor has moved further away/stopped.

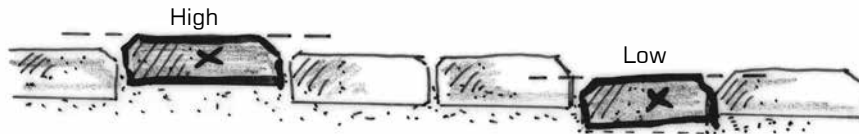

High or low paver: remove paver, adjust bedding sand, drop paver back into place

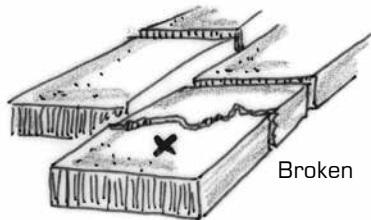

Damaged paver: remove and discard, drop in new paver.

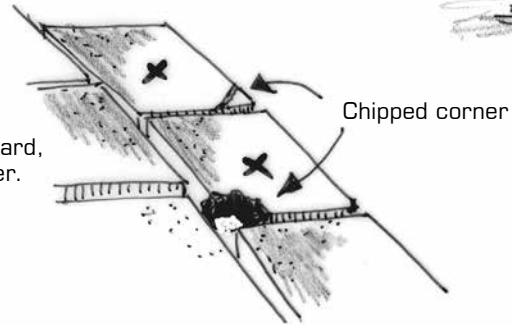

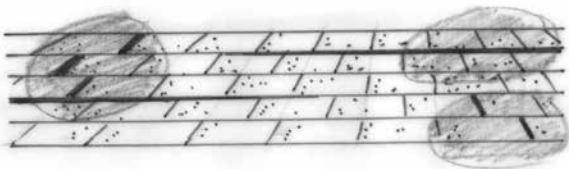
6.9 Checking and adjusting lines and pavers

After initial compaction and before spreading jointing sand, correct alignment, line up pavers using crowbar

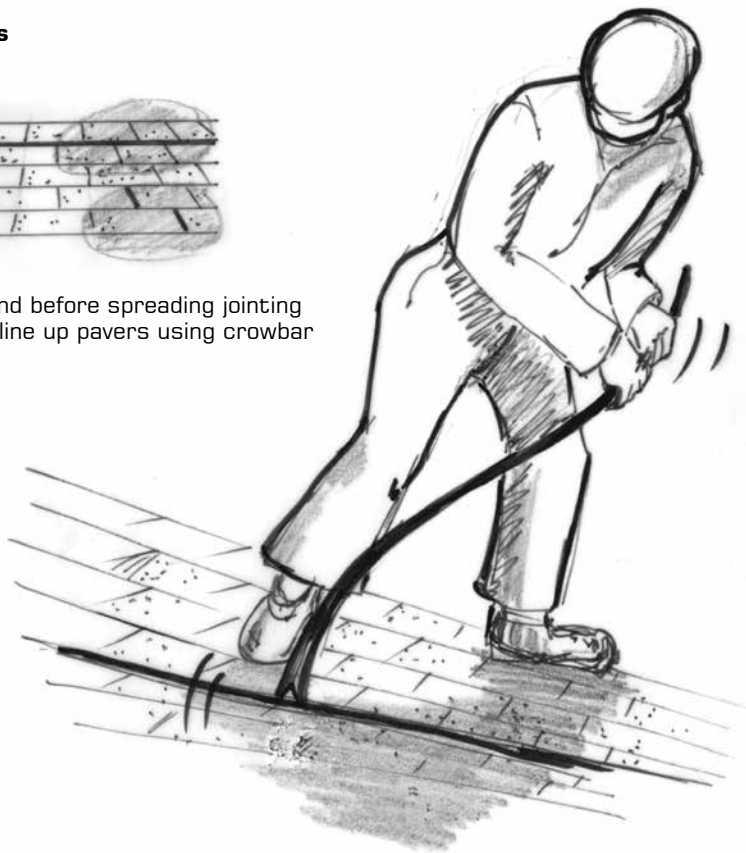

If necessary, re-compact these areas

7.1 Placing and sweeping in jointing sand

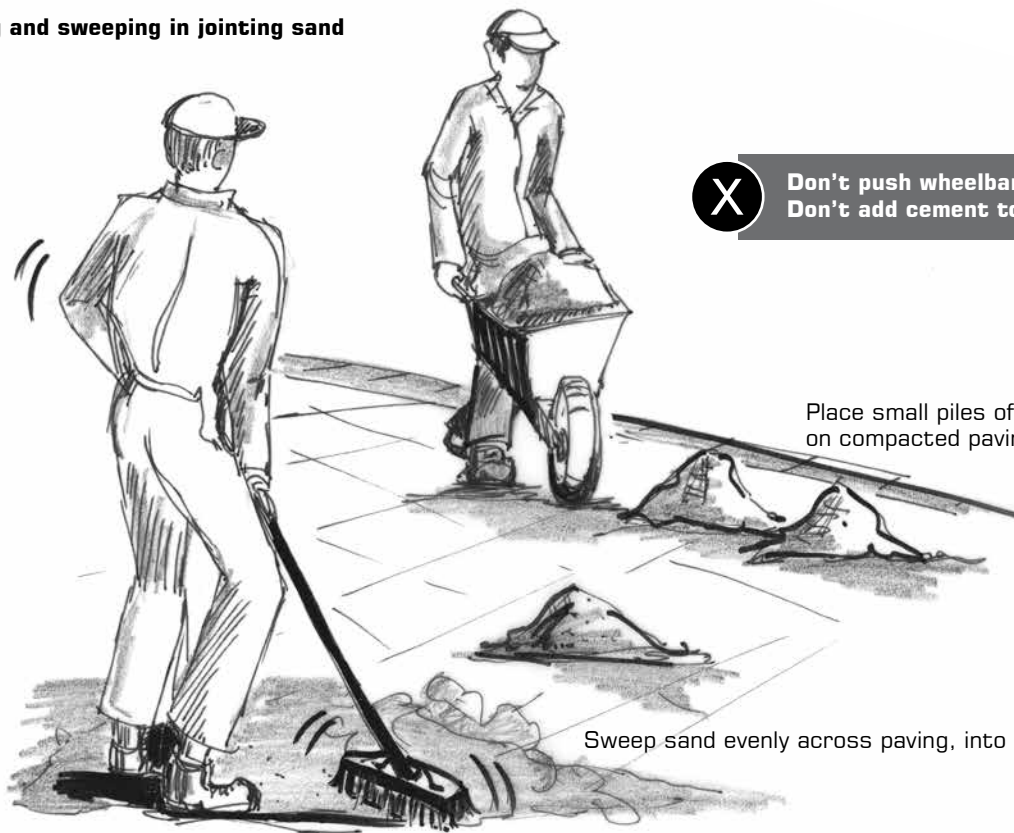

Don't push wheelbarrow over laying edge
Don't add cement to jointing sand

Place small piles of very dry fine sand
on compacted paving

Sweep sand evenly across paving, into joints

7.2 Final compaction

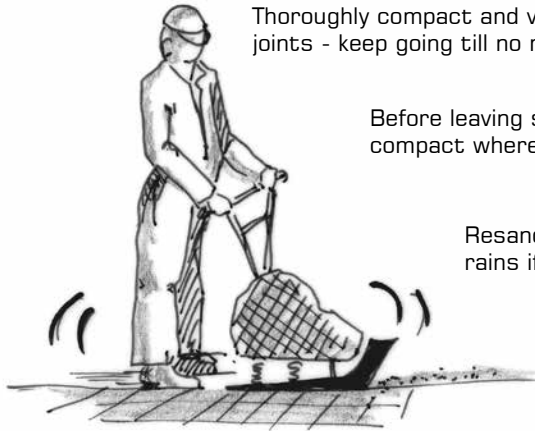

Thoroughly compact and vibrate jointing sand into joints - keep going till no more open joints appear

Before leaving site, inspect, resand/compact where necessary

Resand/compact again after heavy rains if sand has been washed out

To extend paver life, resand within first six months

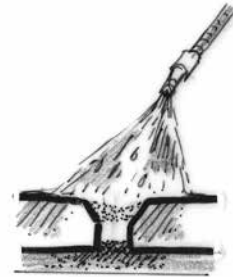

Don't wash sand into joints: "bridge" collapses later

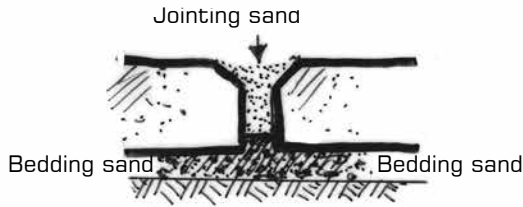

Joint fully compacted with dry sand

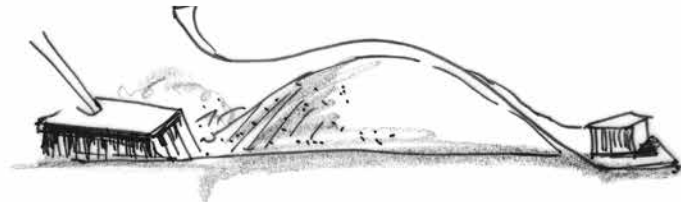

End of day: sweep excess sand into pile, cover with tarp

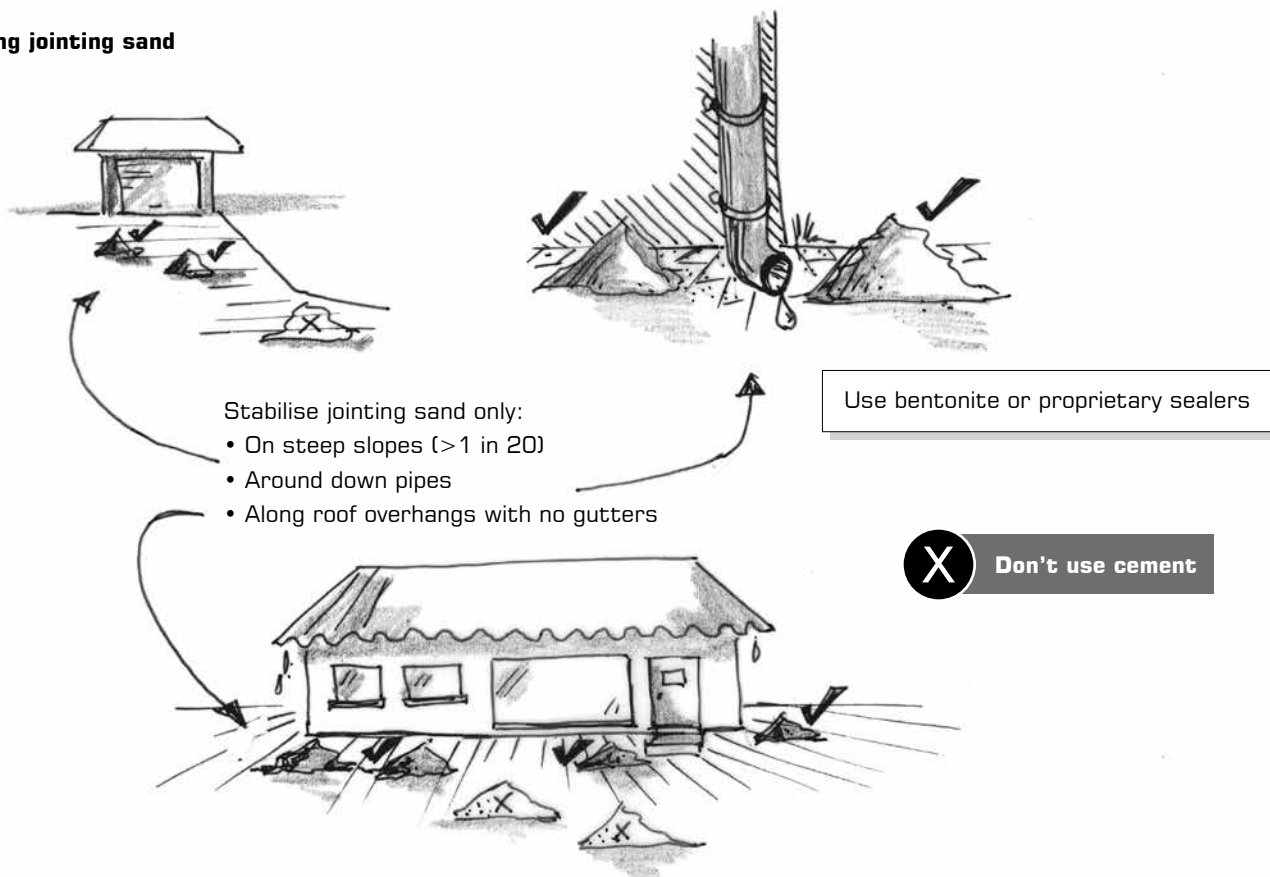
7.3 Stabilising jointing sand

7.4 Temporary edge restraint

At day end, finish paving at angle, place temporary edge restraint across front of laying edge

Cover laying edge with plastic if rain is expected overnight

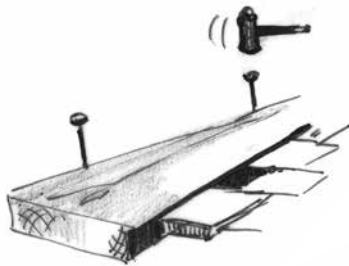

Push edge restraint up against laying edge, secure

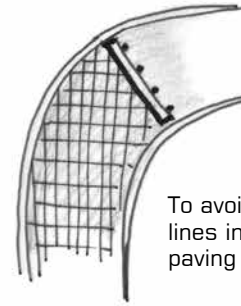
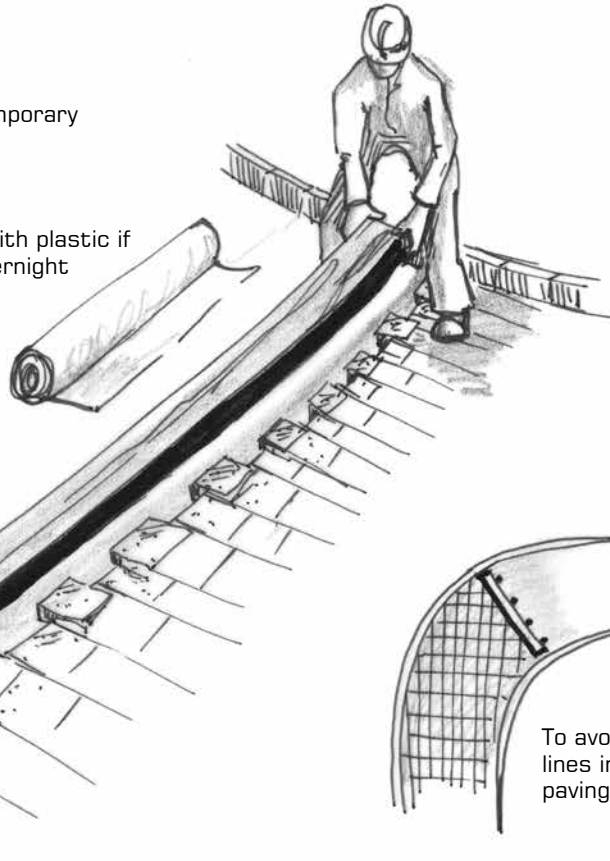

To avoid obvious "day-end" lines in finished paving, stop paving at an angle

Settlement: Remove paver/s carefully, adjust and/or add more sand, replace pavers.

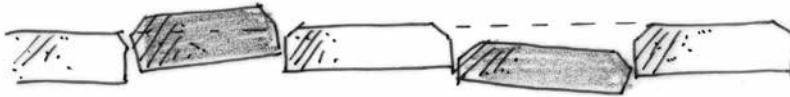

Weeds: Seeds drop into joints, germinate after rain. Remove carefully by hand, or spray paving surface with proprietary weed killer.



Stain removal:

Cover oil stains with cat litter asap – oil is absorbed, litter is then brushed off. Other stains: scrub with hard brush and proprietary detergent, wash off with clean water.

Resand and vibrate: After six months, or after first heavy rain.

Efflorescence: Whitish natural mineral leaching out of pavers will disappear with time, usually after two rainy seasons. Can be removed using acid wash – **expert use only.**

Utility repairs: During laying, mark pavers over underground services. Remove jointing sand, pry up first few blocks (two screwdrivers). Place removed pavers aside, clean. Repair drain or clear pipes. Replace base material, compact, place bedding sand layer. Replace removed pavers, brush dry sand into joints. If possible, resand, vibrate complete area.



Surface sealants (not recommended):

- High initial cost
- Abrasion removes sealer from surface
- Regular maintenance required

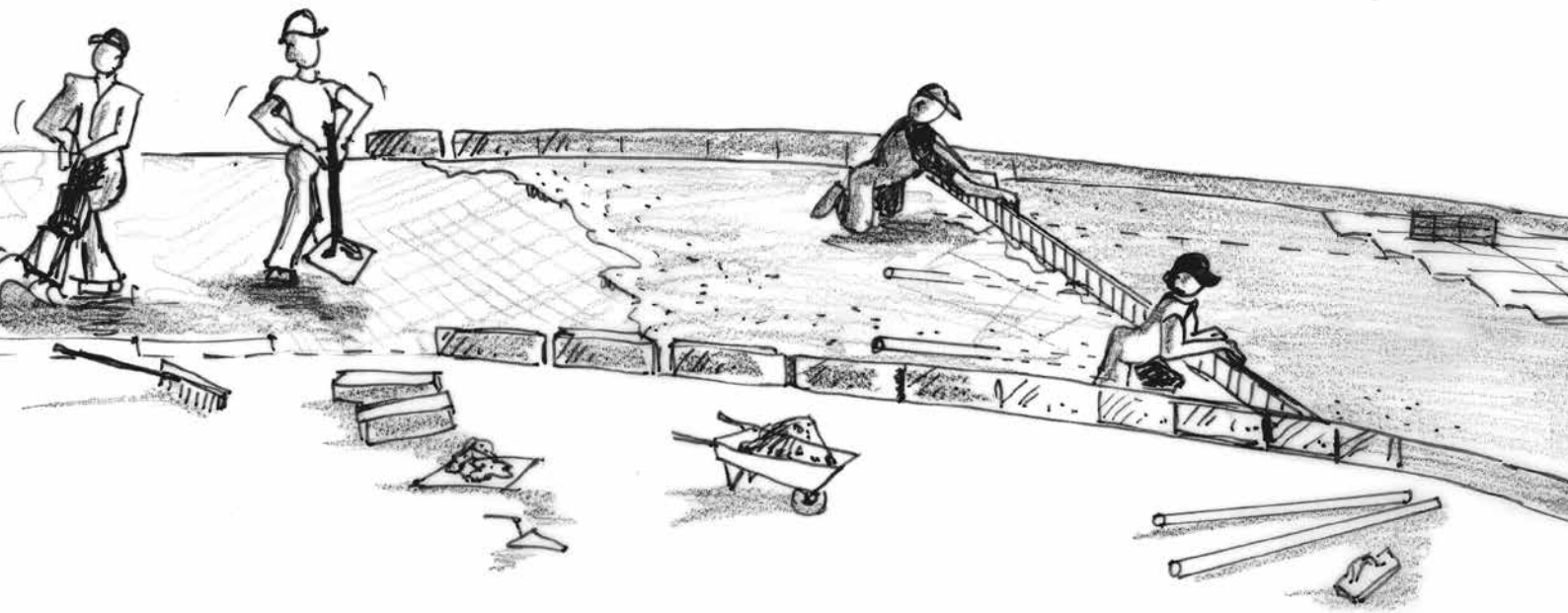

Concrete Manufacturers Association (NPC)

Address: 16 Horn Street, Chloorkop, Kempton Park • **Tel:** 011 805 6742 • **Fax:** 086 524 9216

E-mail: admin@cma.org.za • **Website:** www.cma.org.za